



STM6960

SamHop Microelectronics Corp.

Nov 12 2007 Ver1.1

Dual N-Channel Enhancement Mode Field Effect Transistor

PRODUCT SUMMARY		
V _{DSS}	I _D	R _{DS(ON)} (mΩ) Max
60V	5A	60 @ V _{GS} = 10V 75 @ V _{GS} = 4.5V

FEATURES

- Super high dense cell design for low R_{DS(ON)}.
- Rugged and reliable.
- Surface Mount Package.

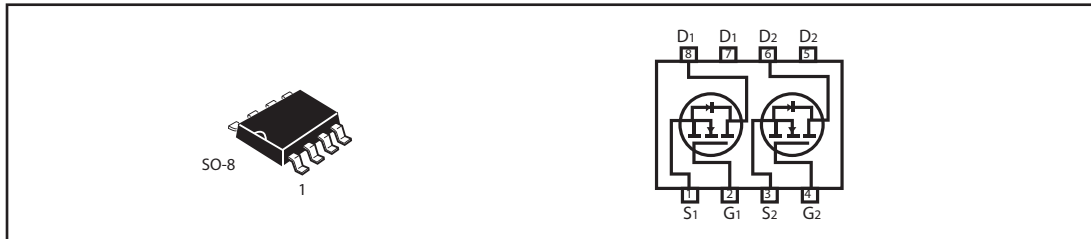

ABSOLUTE MAXIMUM RATINGS (T_A=25°C unless otherwise noted)

Parameter	Symbol	Limit	Unit	
Drain-Source Voltage	V _{DS}	60	V	
Gate-Source Voltage	V _{GS}	±20	V	
Drain Current-Continuous ^a @T _a	I _D	25°C	5	A
		70°C	4.3	A
-Pulsed ^b	I _{DM}	25	A	
Drain-Source Diode Forward Current ^a	I _S	1.7	A	
Maximum Power Dissipation ^a	P _D	T _a =25°C	2	W
		T _a =70°C	1.44	
Operating Junction and Storage Temperature Range	T _J , T _{STG}	-55 to 150	°C	

THERMAL CHARACTERISTICS

Thermal Resistance, Junction-to-Ambient ^a	R _{θJA}	62.5	°C/W
--	------------------	------	------

STM6960

ELECTRICAL CHARACTERISTICS ($T_A = 25^\circ\text{C}$ unless otherwise noted)

Parameter	Symbol	Condition	Min	Typ ^c	Max	Unit
OFF CHARACTERISTICS						
Drain-Source Breakdown Voltage	BV_{DSS}	$V_{GS} = 0V, I_D = 250\mu A$	60			V
Zero Gate Voltage Drain Current	I_{DSS}	$V_{DS} = 48V, V_{GS} = 0V$			1	μA
Gate-Body Leakage	I_{GSS}	$V_{GS} = \pm 20V, V_{DS} = 0V$			± 100	nA
ON CHARACTERISTICS^b						
Gate Threshold Voltage	$V_{GS(th)}$	$V_{DS} = V_{GS}, I_D = 250\mu A$	1.0	1.8	3.0	V
Drain-Source On-State Resistance	$R_{DS(on)}$	$V_{GS} = 10V, I_D = 4.5A$		47	60	m ohm
		$V_{GS} = 4.5V, I_D = 3A$		55	75	m ohm
On-State Drain Current	$I_{D(on)}$	$V_{DS} = 5V, V_{GS} = 10V$	20			A
Forward Transconductance	g_{FS}	$V_{DS} = 5V, I_D = 4.5A$		12		S
DYNAMIC CHARACTERISTICS^c						
Input Capacitance	C_{ISS}	$V_{DS} = 25V, V_{GS} = 0V$ $f = 1.0MHz$		700		pF
Output Capacitance	C_{OSS}			80		pF
Reverse Transfer Capacitance	C_{RSS}			50		pF
Gate resistance	R_g	$V_{GS} = 0V, V_{DS} = 0V, f = 1.0MHz$		5		ohm
SWITCHING CHARACTERISTICS^c						
Turn-On Delay Time	$t_{D(on)}$	$V_{DD} = 30V$ $I_D = 4.5A$ $V_{GS} = 10V$ $R_{GEN} = 3\text{ ohm}$		13		ns
Rise Time	t			10		ns
Turn-Off Delay Time	$t_{D(off)}$			28		ns
Fall Time	t			7		ns
Total Gate Charge	Q_g	$V_{DS} = 48V, I_D = 4.5A, V_{GS} = 10V$		15		nC
		$V_{DS} = 48V, I_D = 4.5A, V_{GS} = 4.5V$		7.5		nC
Gate-Source Charge	Q_{gs}	$V_{DS} = 48V, I_D = 4.5A$		1.6		nC
Gate-Drain Charge	Q_{gd}	$V_{GS} = 10V$		4.3		nC

STM6960

ELECTRICAL CHARACTERISTICS ($T_A=25^{\circ}\text{C}$ unless otherwise noted)

Parameter	Symbol	Condition	Min	Typ ^c	Max	Unit
DRAIN-SOURCE DIODE CHARACTERISTICS^b						
Diode Forward Voltage	V_{SD}	$V_{GS} = 0V, I_s = 1.7A$		0.8	1.2	V

Notes

- a. Surface Mounted on FR4 Board, $t \leq 10\text{sec}$.
- b. Pulse Test: Pulse Width $\leq 300\mu\text{s}$, Duty Cycle $\leq 2\%$.
- c. Guaranteed by design, not subject to production testing.

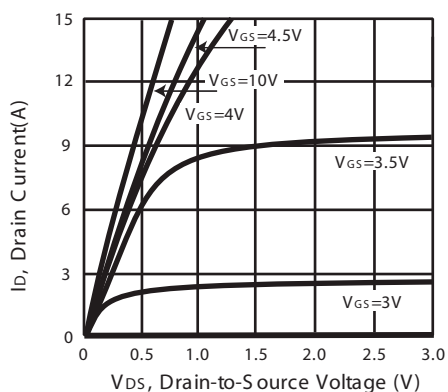

Figure 1. Output Characteristics

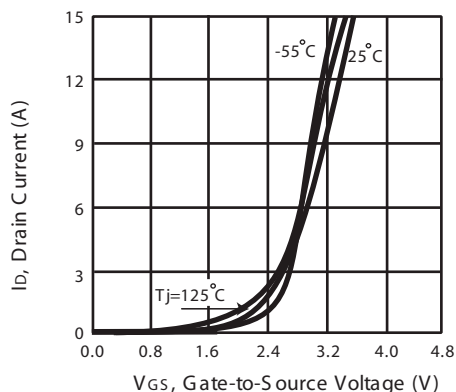

Figure 2. Transfer Characteristics

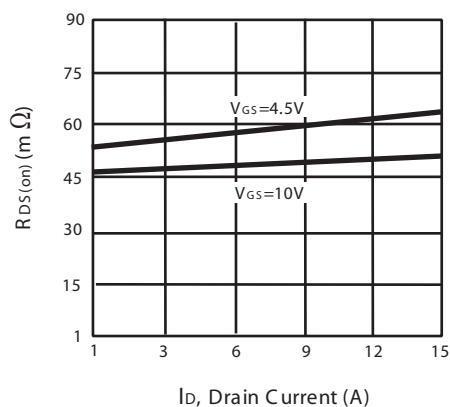

Figure 3. On-Resistance vs. Drain Current and Gate Voltage

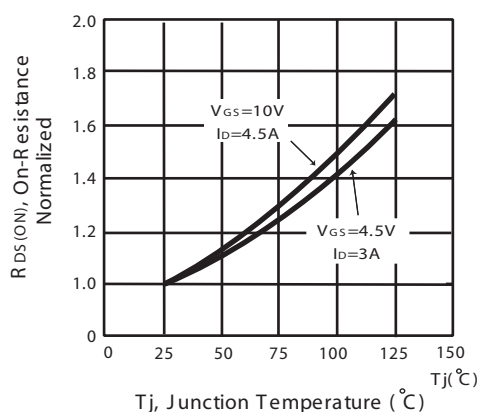

Figure 4. On-Resistance Variation with Drain Current and Temperature

STM6960

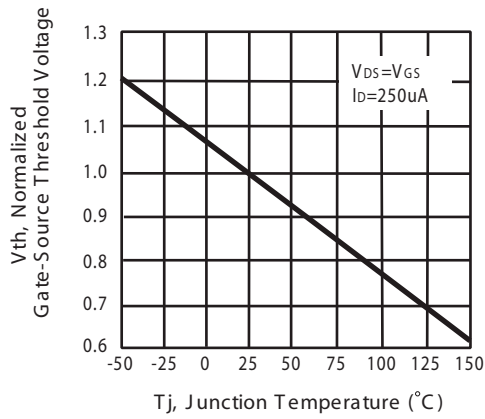

Figure 5. Gate Threshold Variation with Temperature

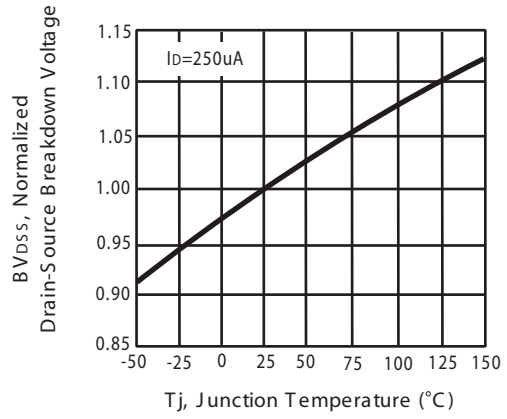

Figure 6. Breakdown Voltage Variation with Temperature

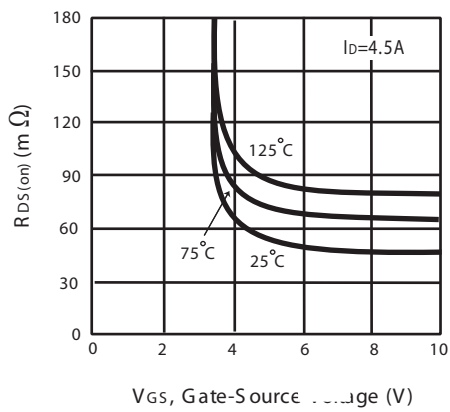

Figure 7. On-Resistance vs. Gate-Source Voltage

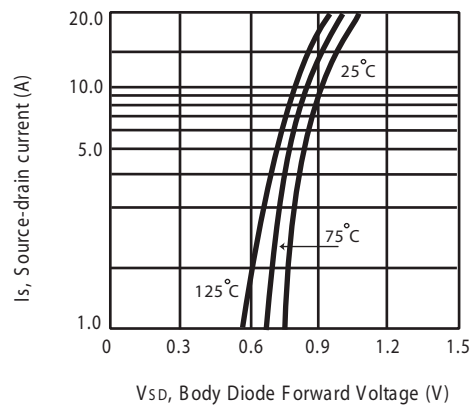
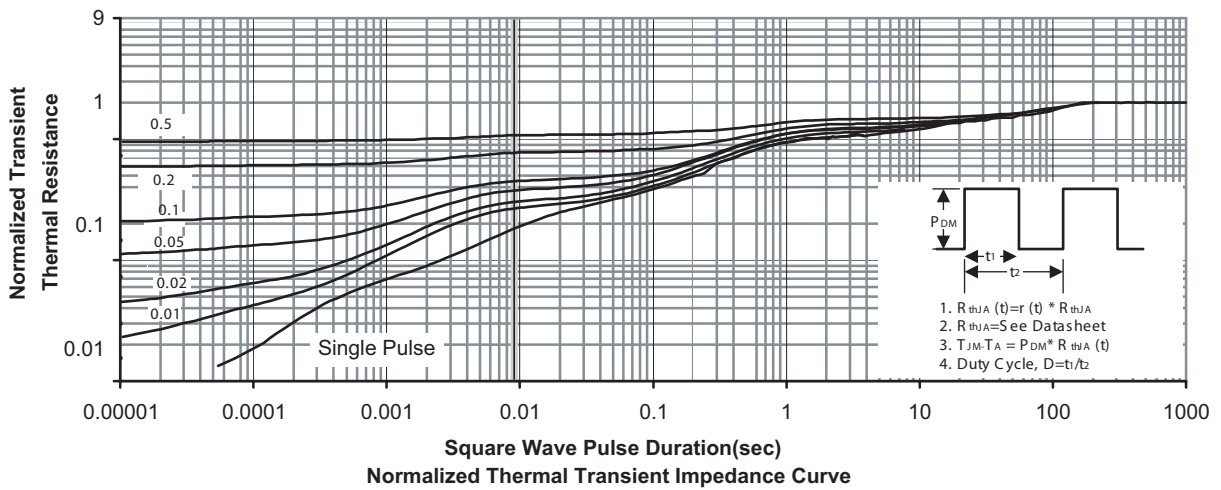
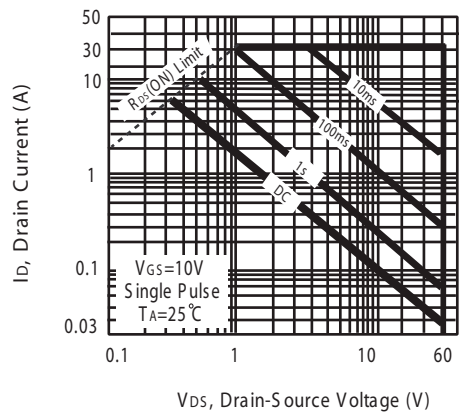
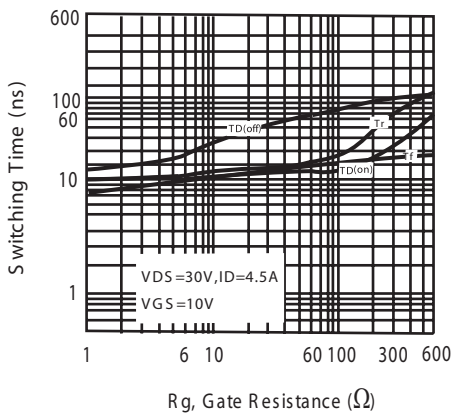
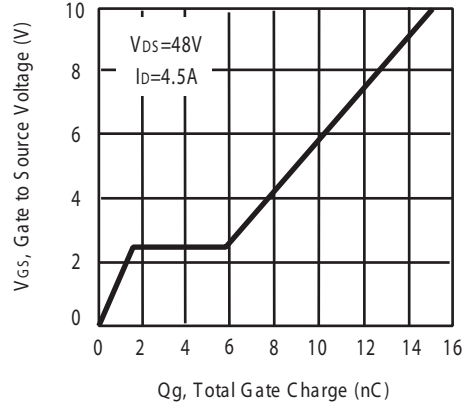
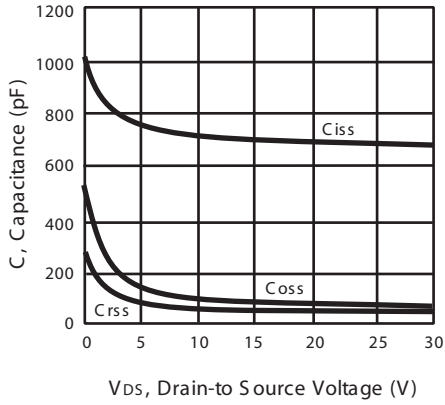

Figure 8. Body Diode Forward Voltage Variation with Source Current

STM6960



STM6960

PACKAGE OUTLINE DIMENSIONS

SO-8

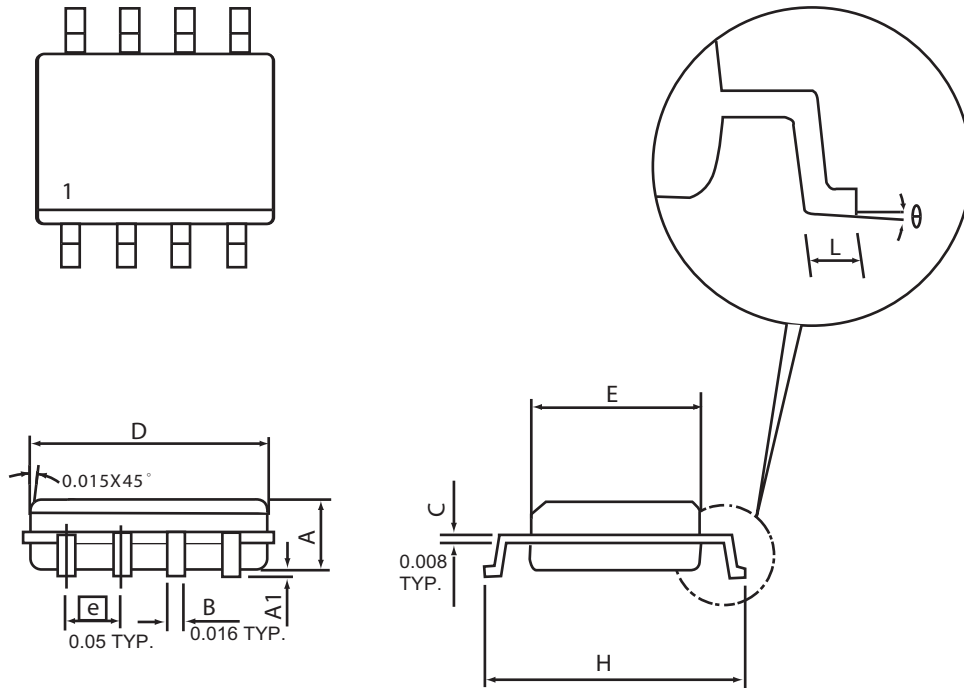

SYMBOLS	MILLIMETERS		INCHES	
	MIN	MAX	MIN	MAX
A	1.35	1.75	0.053	0.069
A1	0.10	0.25	0.004	0.010
D	4.80	4.98	0.189	0.196
E	3.81	3.99	0.150	0.157
H	5.79	6.20	0.228	0.244
L	0.41	1.27	0.016	0.050
θ	0°	8°	0°	8°

STM6960

SO-8 Tape and Reel Data

SO-8 Carrier Tape

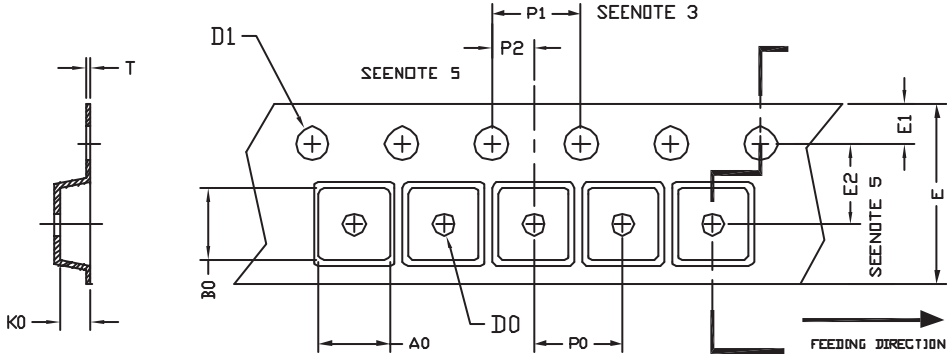

unit:mm

PACKAGE	A0	B0	K0	D0	D1	E	E1	E2	P0	P1	P2	T
SOP 8N 150mil	6.40	5.20	2.10	$\phi 1.5$ (MIN)	$\phi 1.5$ + 0.1 - 0.0	12.0 ± 0.3	1.75	5.5 ± 0.05	8.0	4.0	2.0 ± 0.05	0.3 ± 0.05

SO-8 Reel

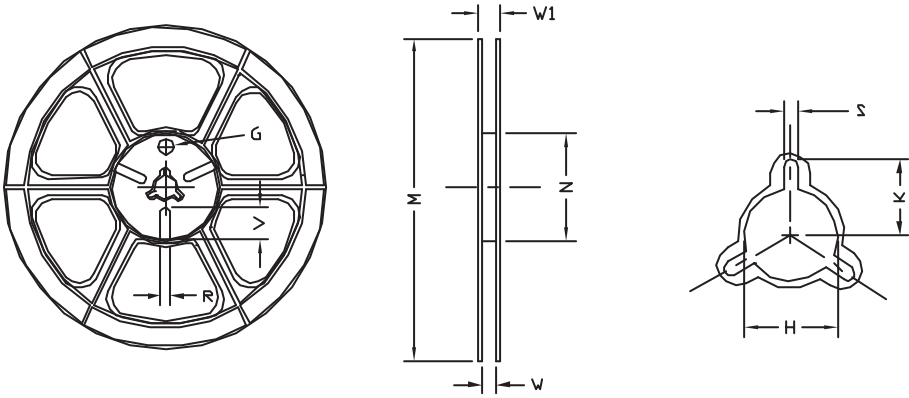

UNIT:mm

TAPE SIZE	REEL SIZE	M	N	W	W1	H	K	S	G	R	V
12 mm	$\phi 330$	330 ± 1	62 ± 1.5	12.4 + 0.2	16.8 - 0.4	$\phi 12.75$ + 0.15	---	2.0 ± 0.15	---	---	---