



DUAL OPERATIONAL AMPLIFIER

■ GENERAL DESCRIPTION

NJM4580 is the dual operational amplifier, specially designed for improving the tone control, which is most suitable for the audio application.

Featuring noiseless, higher gain bandwidth, high output current and low distortion ratio, and it is most suitable not only for acoustic electronic parts of audio pre-amp and active filter, but also for the industrial measurement tools. It is also suitable for the head phone amp at higher output current, and further more, it can be applied for the handy type set operational amplifier of general purpose in application of low voltage single supply type which is properly biased of the input low voltage source.

■ FEATURES

- Operating Voltage ($\pm 2V \sim \pm 18V$)
- Low Input Noise Voltage ($0.8 \mu V_{rms}$ typ.)
- Wide Gain Bandwidth Product (15MHz typ.)
- Low Distortion (0.0005% typ.)
- Slew Rate ($5V/\mu s$ typ.)
- Package Outline DIP8, SIP8, EMP8, SSOP8, DMP8
- Bipolar Technology

■ PACKAGE OUTLINE

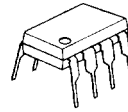

NJM4580D



NJM4580M



NJM4580E

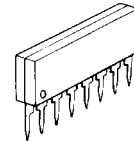

NJM4580L



NJM4580V



■ PIN CONFIGURATION

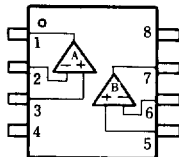

NJM4580D, NJM4580E
NJM4580M, NJM4580V

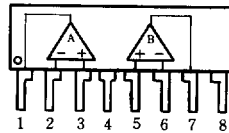

NJM4580L

PIN FUNCTION

1. A OUTPUT
2. A -INPUT
3. A +INPUT
4. V⁻
5. B +INPUT
6. B -INPUT
7. B OUTPUT
8. V⁺

■ EQUIVALENT CIRCUIT (1/2 Shown)

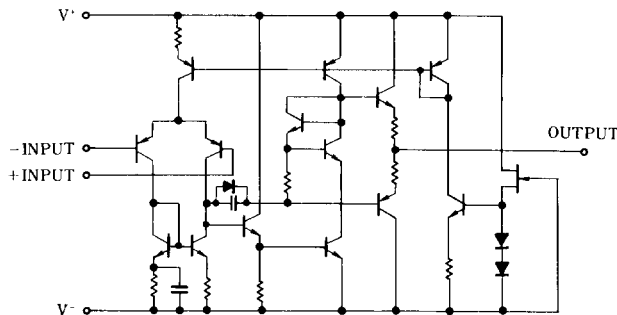



■ ABSOLUTE MAXIMUM RATINGS

(Ta=25°C)

PARAMETER	SYMBOL	RATINGS	UNIT
Differential Input Voltage	V ⁺ /V ⁻	±18	V
Supply Voltage	V _{ic}	±15 (note)	V
Input Voltage	V _{in}	±30 (note)	V
Output Current	I _o	±50	mA
Power Dissipation	P _d	(DIP8) 800	mW
		(SIP8) 800	mW
		(DMP8) 300	mW
		(EMP8) 300	mW
		(SSOP8) 250	mW
Operating Temperature Range	T _{opr}	-20~+75	°C
Storage Temperature Range	T _{stg}	-40~+125	°C

■ ELECTRICAL CHARACTERISTICS

(Ta=25°C, V⁺/V⁻=±15V)

PARAMETER	SYMBOL	TEST CONDITION	MIN.	TYP.	MAX.	UNIT
Input Offset Voltage	V _{IO}	R _S ≤ 10kΩ	—	0.5	3	mV
Input Offset Current	I _{IO}		—	5	200	nA
Input Bias Current	I _{IB}		—	100	500	nA
Large Signal Voltage Gain	A _V	R _L ≥ 2kΩ, V _O = ±10V	90	110	—	dB
Output Voltage Swing	V _{OM}	R _L ≥ 2kΩ	±12	±13.5	—	V
Input Common Mode Voltage Range	V _{ICM}		±12	±13.5	—	V
Common Mode Rejection Ratio	CMR	R _S ≤ 10kΩ	80	110	—	dB
Supply Voltage Rejection Ratio	SVR	R _S ≤ 10kΩ	80	110	—	dB
Operating Current	I _{CC}		—	6	9	mA
Slew Rate	SR	R _L ≥ 2kΩ	—	5	—	V/μs
Gain Bandwidth Product	GB	f=10kHz	—	15	—	MHz
Total Harmonic Distortion	THD	A _V = 20dB, V _O = 5V, R _L = 2kΩ, f=1kHz	—	0.0005	—	%
Input Noise Voltage	V _{NI}	RIAA R _S = 2.2kΩ, 30kHz LPF	—	0.8	—	μV _{rms}

4



■ TYPICAL CHARACTERISTICS

Maximum Output Voltage Swing vs. Load Resistance

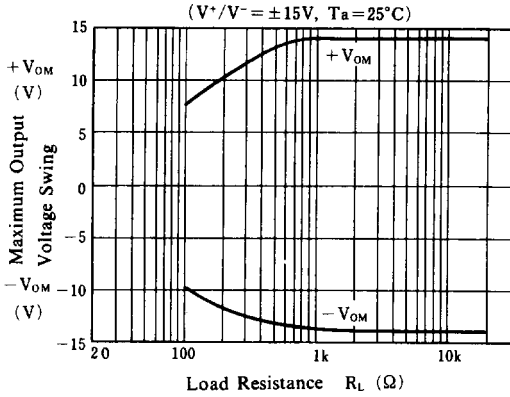

Maximum Output Voltage Swing vs. Frequency

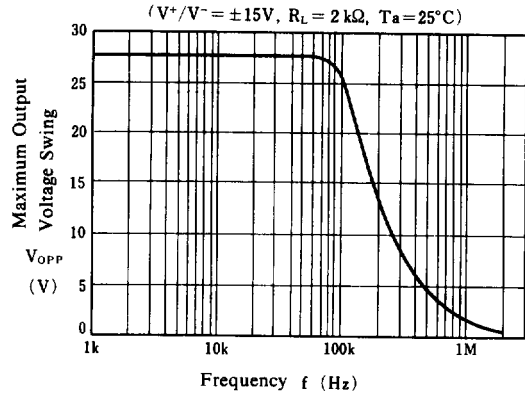

Output Voltage Swing vs. Output Current

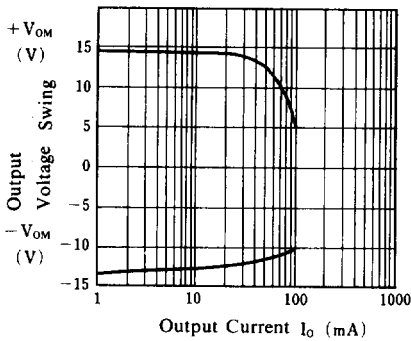

Equivalent Input Noise Voltage vs. Frequency

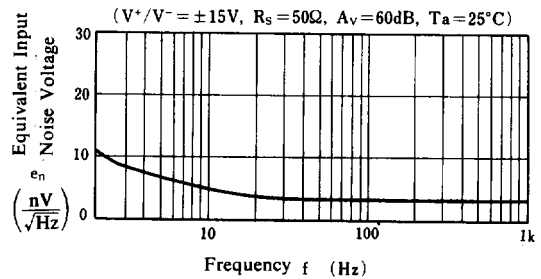

Operating Current vs. Temperature

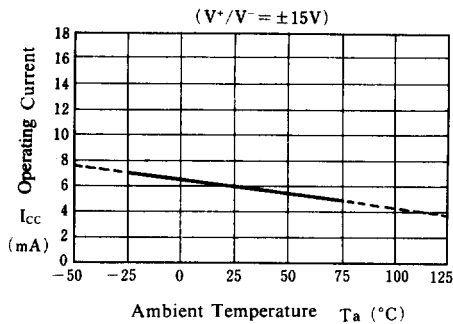

Output Voltage Swing vs. Temperature

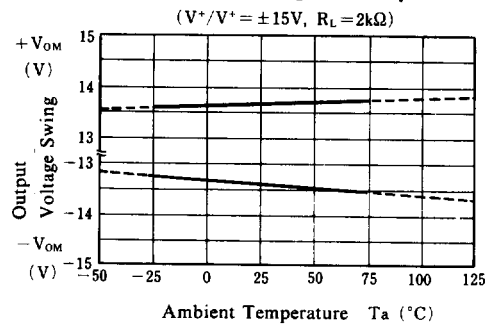

4



■ TYPICAL CHARACTERISTICS

Input Offset Voltage vs. Temperature

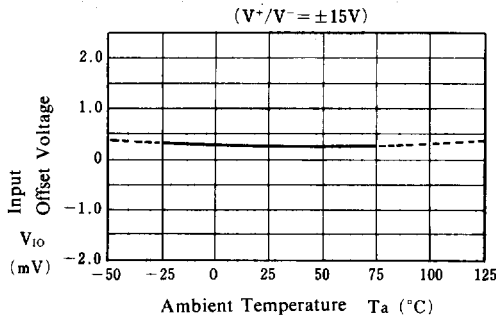

Input Bias Current vs. Temperature

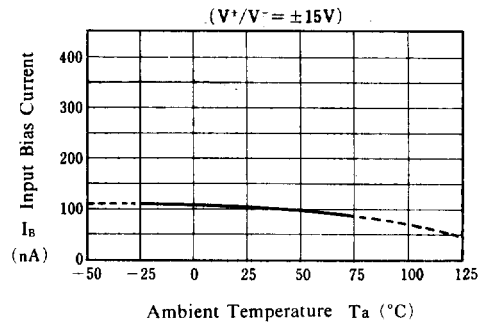

Maximum Output Voltage Swing vs. Operating Voltage

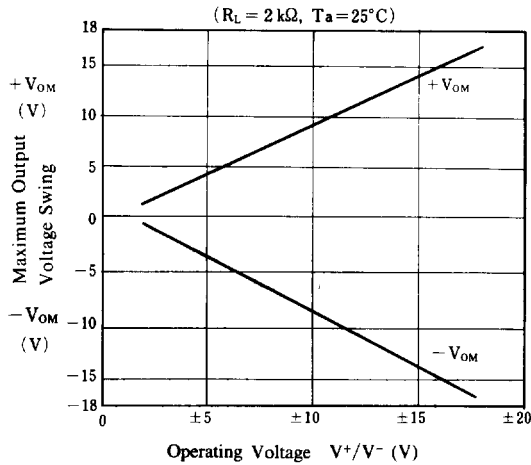

Operating Current vs. Operating Voltage

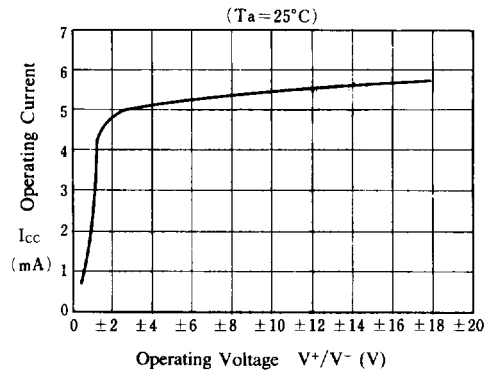

Total Harmonic Distortion vs. Output Voltage

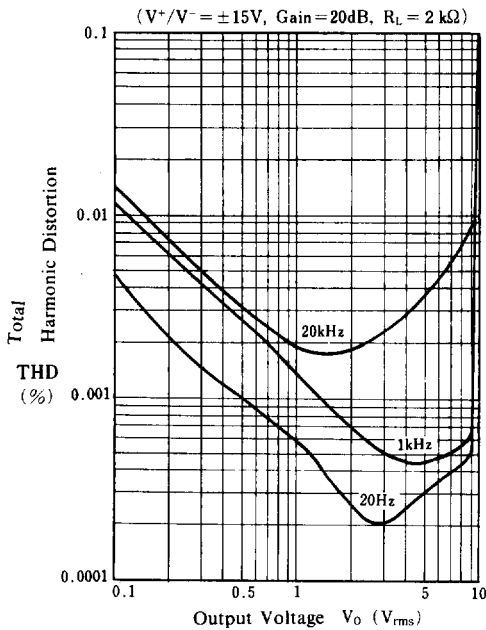

Voltage Gain, Phase vs. Frequency

