

MACKIE®

M•1400/M•1400i OWNER'S MANUAL

FR SERIES™ FAST RECOVERY

HIGH-CURRENT POWER AMPLIFIER

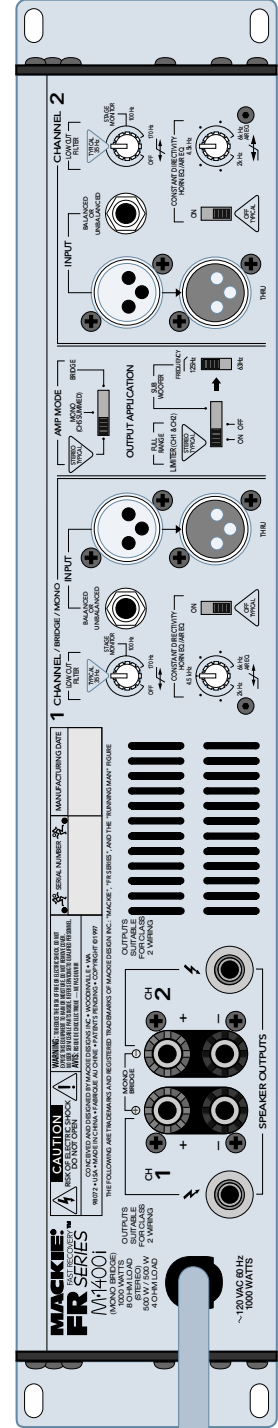
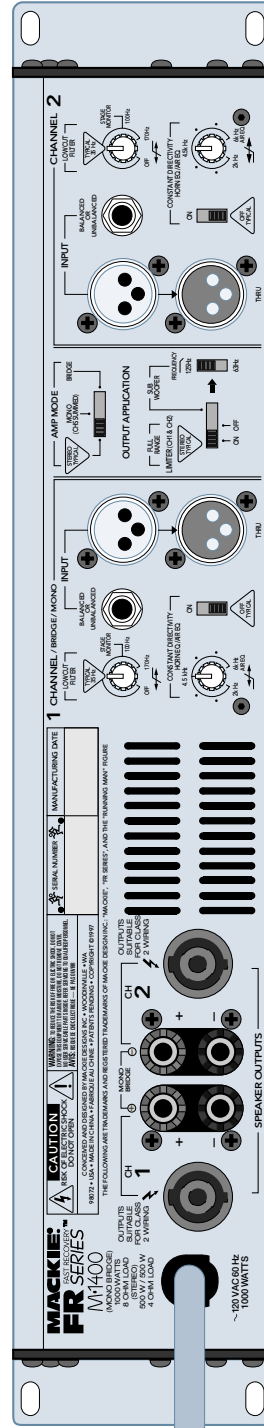
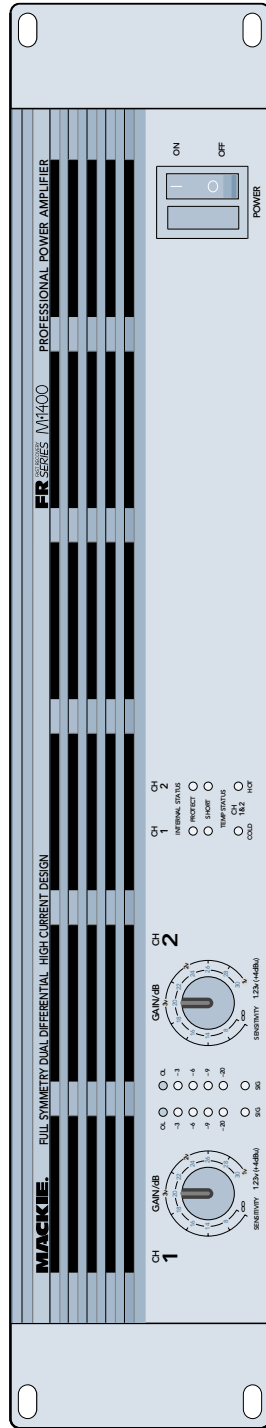

CAUTION AVIS

RISK OF ELECTRIC SHOCK
DO NOT OPEN
RISQUE DE CHOC ELECTRIQUE
NE PAS OUVRIR

**CAUTION: TO REDUCE THE RISK OF ELECTRIC SHOCK
DO NOT REMOVE COVER (OR BACK)
NO USER-SERVICEABLE PARTS INSIDE
REFER SERVICING TO QUALIFIED PERSONNEL**
**ATTENTION: POUR EVITER LES RISQUES DE CHOC
ELECTRIQUE, NE PAS ENLEVER LE COUVERCLE. AUCUN
ENTRETIEN DE PIECES INTERIEURES PAR L'USAGER. CONFIER
L'ENTRETIEN AU PERSONNEL QUALIFIE.**
**AVIS: POUR EVITER LES RISQUES D'INCENDIE OU
D'ELECTROCUTION, N'EXPOSEZ PAS CET ARTICLE
A LA PLUIE OU A L'HUMIDITE**



The lightning flash with arrowhead symbol within an equilateral triangle is intended to alert the user to the presence of uninsulated "dangerous voltage" within the product's enclosure, that may be of sufficient magnitude to constitute a risk of electric shock to persons.
Le symbole éclair avec point de flèche à l'intérieur d'un triangle équilatéral est utilisé pour alerter l'utilisateur de la présence à l'intérieur du coffret de "voltage dangereux" non isolé d'ampleur suffisante pour constituer un risque d'électrocution.



The exclamation point within an equilateral triangle is intended to alert the user of the presence of important operating and maintenance (servicing) instructions in the literature accompanying the appliance.
Le point d'exclamation à l'intérieur d'un triangle équilatéral est employé pour alerter les utilisateurs de la présence d'instructions importantes pour le fonctionnement et l'entretien (service) dans le livret d'instruction accompagnant l'appareil.

SAFETY INSTRUCTIONS

1. Read Instructions — All the safety and operation instructions should be read before this Mackie product is operated.
2. Retain Instructions — The safety and operating instructions should be kept for future reference.
3. Heed Warnings — All warnings on this Mackie product and in these operating instructions should be followed.
4. Follow Instructions — All operating and other instructions should be followed.
5. Water and Moisture — This Mackie product should not be used near water — for example, near a bathtub, washbowl, kitchen sink, laundry tub, in a wet basement, near a swimming pool, swamp or salivating St. Bernard dog, etc.
6. Ventilation — This Mackie product should be situated so that its location or position does not interfere with its proper ventilation. For example, the Component should not be situated on a bed, sofa, rug, or similar surface that may block any ventilation openings, or placed in a built-in installation such as a bookcase or cabinet that may impede the flow of air through ventilation openings.
7. Heat — This Mackie product should be situated away from heat sources such as radiators, or other devices which produce heat.

PORTABLE CART WARNING



Carts and stands - The Component should be used only with a cart or stand that is recommended by the manufacturer.
 A Component and cart combination should be moved with care. Quick stops, excessive force, and uneven surfaces may cause the Component and cart combination to overturn.

8. Power Sources — This Mackie product should be connected to a power supply only of the type described in these operation instructions or as marked on this Mackie product.
9. Power Cord Protection — Power supply cords should be routed so that they are not likely to be walked upon or pinched by items placed upon or against them, paying particular attention to cords at plugs, convenience receptacles, and the point where they exit this Mackie product.
10. Object and Liquid Entry — Care should be taken so that objects do not fall into and liquids are not spilled into this Mackie product.
11. Damage Requiring Service — This Mackie product should be serviced only by qualified service personnel when:
 - A. The power-supply cord or the plug has been damaged; or
 - B. Objects have fallen, or liquid has spilled into this Mackie product; or
 - C. This Mackie product has been exposed to rain; or
 - D. This Mackie product does not appear to operate normally or exhibits a marked change in performance; or
 - E. This Mackie product has been dropped, or its chassis damaged.

12. Servicing — The user should not attempt to service this Mackie product beyond those means described in this operating manual. All other servicing should be referred to the Mackie Service Department.

13. To prevent electric shock, do not use this polarized plug with an extension cord, receptacle or other outlet unless the blades can be fully inserted to prevent blade exposure.

Pour prévenir les chocs électriques ne pas utiliser cette fiche polarisée avec un prolongateur, un prise de courant ou une autre sortie de courant, sauf si les lames peuvent être insérées à fond sans laisser aucune partie à découvert.

14. Grounding or Polarization — Precautions should be taken so that the grounding or polarization means of this Mackie product is not defeated.

15. This apparatus does not exceed the Class A/Class B (whichever is applicable) limits for radio noise emissions from digital apparatus as set out in the radio interference regulations of the Canadian Department of Communications.

ATTENTION — Le présent appareil numérique n'émet pas de bruits radioélectriques dépassant les limites applicables aux appareils numériques de class A/de class B (selon le cas) prescrites dans le règlement sur le brouillage radioélectrique édicté par les ministere des communications du Canada.



This product has been tested and complies with the following standards and directives as set forth by the European Union:

- EN 50013 1990 Emissions
- EN 50020 1988 Immunity
- EN 60065 1994 and IEC 65: 1985 Safety

WARNING — To reduce the risk of fire or electric shock, do not expose this appliance to rain or moisture.



Lend Me Your Ears

Exposure to extremely high noise levels may cause permanent hearing loss.

Individuals vary considerably in susceptibility to noise-induced hearing loss, but nearly everyone will lose some hearing if exposed to sufficiently intense noise for a period of time. The U.S. Government's Occupational Safety and Health Administration (OSHA) has specified the permissible noise level exposures shown in this chart.

Duration Per Day In Hours	Sound Level dBA, Slow Response	Typical Example
8	90	Duo in small club
6	92	
4	95	Subway Train
3	97	
2	100	Very loud classical music
1.5	102	
1	105	Lori screaming at Ron about deadlines
0.5	110	
0.25 or less	115	Loudest parts at a rock concert

According to OSHA, any exposure in excess of these permissible limits could result in some hearing loss. To ensure against potentially dangerous exposure to high sound pressure levels, it is recommended that all persons exposed to equipment capable of producing high sound pressure levels (such as this amplification system) use hearing

protectors while this unit is in operation. Ear plugs or protectors in the ear canals or over the ears must be worn when oper-

ating this amplification system in order to prevent a permanent hearing loss if exposure is in excess of the limits set forth here.

INTRODUCTION

Thank you for choosing a Mackie Designs power amplifier! We appreciate your vote of confidence for the folks in Woodinville who specialize in awesome and affordable audio. The Mackie Designs M•1400 and M•1400i Power Amplifiers are designed to fulfill the amplification needs of almost any type of application. They boast a wealth of features you'd expect to pay extra for — like subwoofer filtering, constant directivity equalization, speaker-protecting limiter, and gobs of ultra-clean power, to name a few.

Perhaps the most important feature of the FR Series™ Power Amplifiers is the attention to detail in every aspect of the design. At Mackie, we know what it takes to be roadworthy. After all, our mixers have traveled all over the world under the worst of conditions, and we've applied what we've learned to the mechanical design of our amplifiers.

Roadworthiness is only part of the picture. We know that reliability is paramount to sound reinforcement. That's why we use double-sided thru-hole-plated fiberglass printed circuit boards. That's why our engineers have subjected the amplifier to the most rigorous and punishing tests imaginable, to fine-tune the design and extend its limits beyond those of ordinary amplifiers.

Fast Recovery — where the "FR" comes from — is more than a buzzword. It is based on real, proven design principles. The result is an amplifier that performs better than conventional designs when presented with adverse conditions. One of the most difficult things for a power amplifier to handle is clipping. Conventional designs use lots of negative feedback to provide stability and lower

distortion. When clipping occurs, this "feedback" causes high-frequency sticking, keeping the amplifier "latched" in the clipping state longer than necessary. This results in painfully audible distortion. Our Fast Recovery design eliminates this high-frequency sticking and allows the amplifier to remain stable when powering highly reactive loads at high volume levels.

You may wonder why a power amp even needs an owner's manual. After all, you just plug in a few cables and power it up. Well, it's almost that simple. There's just a few things that we'd like you to be aware of, and we'll discuss those right away — please see the **Quick Start** on the next page.

Then go ahead and read the entire manual. The M•1400/M•1400i amplifiers have a wealth of useful features, and each of them is explained in detail.

Note: The only difference between the M•1400 and M•1400i are the speaker output connectors: in addition to the binding posts, the M•1400 has Speakon® connectors while the M•1400i has 1/4" TS jacks.

Please write your serial number here for future reference (i.e., insurance claims, tech support, return authorization, etc.):

Purchased at:

Date of purchase:



READ THIS PAGE!

QUICK START

I got ants in my pants and I got to dance!

INSTALLATION



The M•1400/M•1400i amp can be mounted in any standard rack system (see page 23), or placed horizontally on a floor or table. The heavier internal components are located towards the front of the chassis to make it easier to hold the amp by its front handles.



IMPORTANT: The amplifier draws its ventilation air in from the front and out through the side panels. It needs plenty of fresh air to stay cool.

DO NOT BLOCK THE VENTILATION PORTS (see page 23).

CONNECTIONS AND SETTINGS

1. Be sure the POWER 7 switch is off before making connections.
2. Turn the GAIN 1 controls fully down (counterclockwise) for now.
3. Set both LOW CUT FILTER 12 controls to their TYPICAL marks (35Hz).
4. Set both CONSTANT DIRECTIVITY 13 switches OFF (unless you're using constant directivity horns with compression drivers).
5. Set the LIMITER 20 switch on.

Note: If you're using the M•1400/M•1400i to power a subwoofer, you probably do not need an external crossover. Please see SUBWOOFER 21 on page 21 for details.

6. Determine which AMP MODE 15 is best for your application:

- STEREO mode (separate left and right inputs, separate left and right outputs) is the typical setup for amplifying stereo signals.
- MONO mode (sometimes called Dual-Mono mode – one mono input, two mono outputs) is for sending a mono signal to two different speaker sets, with separately-adjustable level controls.
- BRIDGE mode (sometimes called Bridged-Mono – one mono input, one mono output) uses both sides of the amp to double the power to one speaker set. An M•1400/M•1400i power amplifier, set to BRIDGE mode, delivers 1400 watts (into 4 ohms). Garsh!

Note: 4 ohms is the minimum impedance you should connect to the amplifier in BRIDGE mode. If you connect a lower impedance load in BRIDGE mode, the SHORT 5 LEDs may light, putting the amplifier into PROTECT 4 mode.

Set the AMP MODE 15 switch accordingly.

7. In STEREO mode, connect line-level cables from your signal source to the M•1400/M•1400i's INPUT 10 jacks, either XLR or TRS:

- The XLR and TRS inputs for each channel are wired in parallel.
- The balanced XLR inputs are wired pin 2 = hot (+), pin 3 = cold (-) and pin 1 = shield (ground).
- The 1/4" TRS inputs are wired tip = hot (+), ring = cold (-) and sleeve = shield (ground), and can accept either balanced (TRS) or unbalanced (TS) cables.

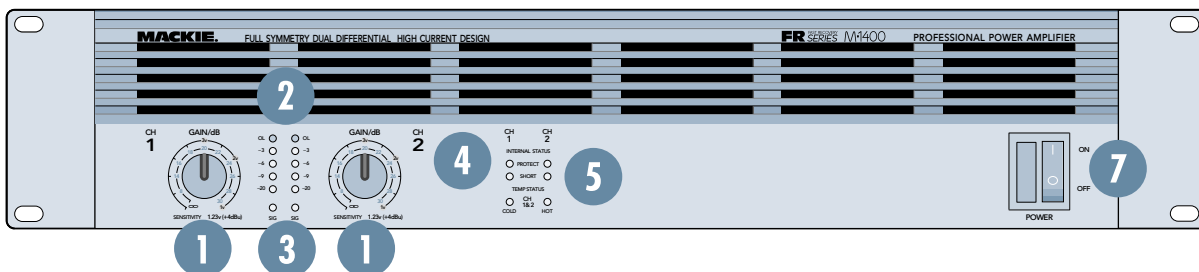

8. In MONO and BRIDGE modes, connect an input cable to CHANNEL 1's INPUT only, and nothing into CHANNEL 2's INPUT. (You could plug into CHANNEL 2's input, it just won't do anything.)
9. In STEREO and MONO modes, connect speaker cables to the SPEAKER OUTPUTS 9, either binding posts, 1/4" jacks, or Speakon®, depending on your model:
 - The binding post connectors are wired red = hot (+) and black = cold (-).
 - The 1/4" jacks are wired tip = hot (+) and ring = cold (-).
 - The Speakon connectors are wired pin 1+ = hot (+) and pin 1- = cold (-).
10. In BRIDGE mode, connect the binding post cable like this: the hot (+) side goes in the CHANNEL 1 SPEAKER OUTPUTS 9 red post and the cold (-) side goes in CHANNEL 2's red post. Plug nothing into the black posts, Speakon jacks (on the M•1400), or the 1/4" TS jacks (on the M•1400i).
11. Connect the other ends of the speaker cables to your loudspeakers.
12. Plug the amp's power cord 8 into an outlet properly configured with the correct voltage for your amplifier, and capable of delivering enough current to reach full power.
13. Make sure your signal source (feeding the M•1400/M•1400i's inputs) is powered up and delivering signal to the amp.
14. Turn the M•1400/M•1400i's POWER 7 switch on and verify that the signal present (SIG) LEDs are blinking.
15. Slowly turn both GAIN 1 controls up: You should hear the music and see the SIG 3 and meter 2 LEDs flashing. If the topmost LEDs (named OL, for OverLoad)

are flashing, turn down either the GAIN controls on the amp or the source signal's output level controls (i.e., master faders). The point is: The OL LEDs should never light up.

16. For quieter listening, it is preferable to adjust the amp's GAIN 1 controls rather than the source signal's output level (unless you have the source's control all the way up!).
17. Start dancing, but don't let the ants out of your pants.

Things You Must Remember:



- Read and follow the safety instructions on page 2, and the hearing protection details on page 3, before using the amplifier.
- Never plug amplifier outputs into anything except speakers (unless you have an outboard box specifically designed to handle speaker-level signals).
- Before making connections to an amp or reconfiguring an amp's routing, turn the amp's level (GAIN) controls down, turn the power off, make the changes, turn the power back on, and then turn the level controls back up.
- If you shut down your equipment, turn off the amplifiers first. When powering up, turn on the amplifiers last.
- Save the shipping boxes! You may need them someday, and you probably don't want to have to pay for them again.

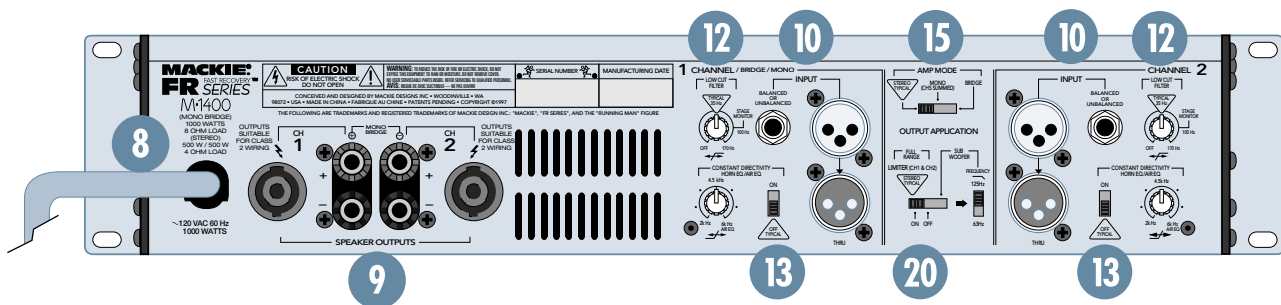

HOW TO USE THIS MANUAL

APPLICATION DIAGRAMS

Mackie's gang of illustrators have created easy-to-understand diagrams of popular studio and live-sound setups. Your setup will probably be different in some way, but these diagrams will help you see the big picture so you can add your own finishing touches.

FEATURE DESCRIPTIONS: MIND BOGGLING DETAILS

Each and every knob, switch, and connector on the M•1400/M•1400i power amplifier is explained in depth here. Throughout this section you'll find illustrations, with each feature numbered like this ❶. If you're curious about a feature, simply locate it on the appropriate illustration, note the number attached to it, and find that number in the nearby paragraphs.



This icon marks information that is critically important or unique to the M•1400/M•1400i. For your own good, read them and remember them. We may call you someday and quiz you.



This icon leads you to in-depth explanations of features and practical tips. While not mandatory, they'll have some valuable information.

GENERAL PRECAUTIONS AND CONSIDERATIONS

This section discusses important things to keep in mind when installing and using the M•1400/M•1400i, including rack mounting, AC power, and wiring.

SERVICE INFO

If you are having a problem setting up your amplifier, please turn here for some troubleshooting information. You will also find information on what to do if your amplifier should ever need servicing.

TECHNICAL INFO

This is where you can find detailed specifications, including a rather lovely block diagram. This will help you quickly verify product performance and capability. Careful and extensive research has shown that reading and memorizing specifications will not make you the life and soul of the party. Let that be a warning.

FURTHER INFO

Please come on by and visit our website:
www.mackie.com

It contains lots of useful information regarding this and other Mackie products.

CONTENTS

Lend Me Your Ears	3
INTRODUCTION	3
READ THIS PAGE!	4
QUICK START	4
INSTALLATION	4
CONNECTIONS AND SETTINGS	4
HOW TO USE THIS MANUAL	6
APPLICATION DIAGRAMS	8
FEATURE DESCRIPTIONS	11
1 GAIN	11
2 METERS	12
3 SIG	13
4 PROTECT	13
5 SHORT	13
6 TEMP STATUS	14
7 POWER	14
8 POWER CORD	15
9 SPEAKER OUTPUTS	15
10 INPUT	16
11 THRU	18
12 LOW CUT FILTER	18
13 CONSTANT DIRECTIVITY	18
14 CD Frequency	19
15 AMP MODE	19
18 BRIDGE	20
19 OUTPUT APPLICATION	20
20 LIMITER	20
21 SUBWOOFER	21
GENERAL PRECAUTIONS AND CONSIDERATIONS	23
RACK MOUNTING	23
THERMAL CONSIDERATIONS	23
AC POWER CONSIDERATIONS	23
INPUT WIRING	24
OUTPUT WIRING	24
70V DISTRIBUTION SYSTEMS	25
APPENDIX A: Service Info	26
TROUBLESHOOTING	26
REPAIR	27
APPENDIX B: Technical Info	28
SPECIFICATIONS M•1400/M•1400i	28
BLOCK DIAGRAM M•1400/M•1400i	30
COLOPHON	31



APPLICATION DIAGRAMS

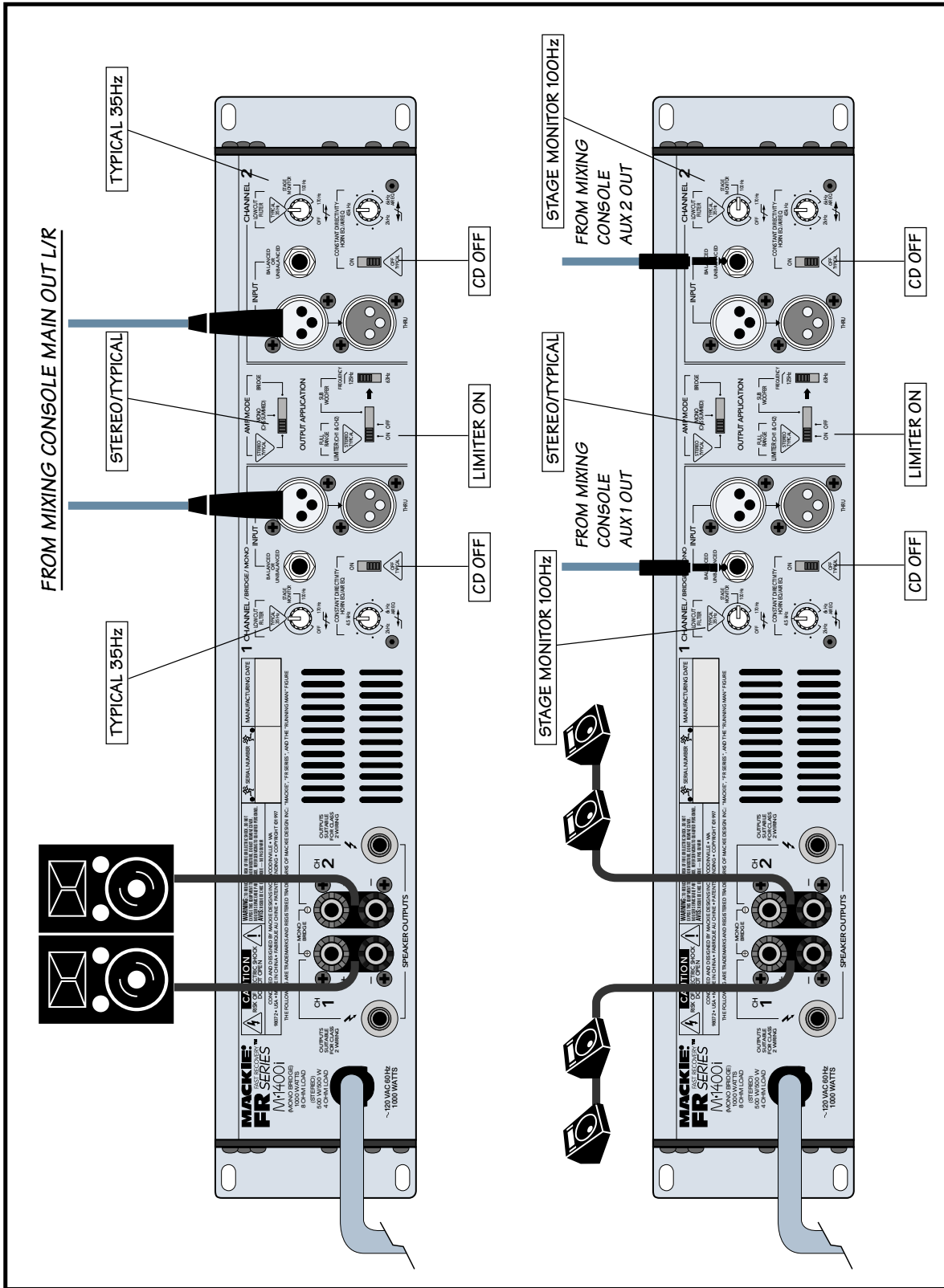

TWO M-1400i's: MAIN SPEAKERS AND STAGE MONITORS

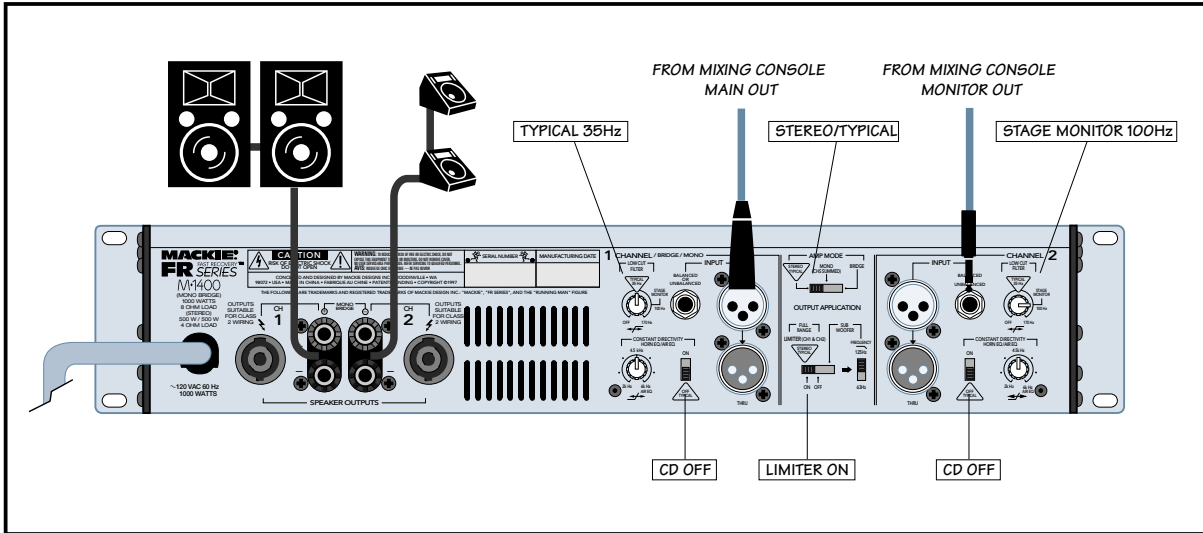

M•1400 MAIN SPEAKERS AND STAGE MONITORS WITH ONE AMPLIFIER

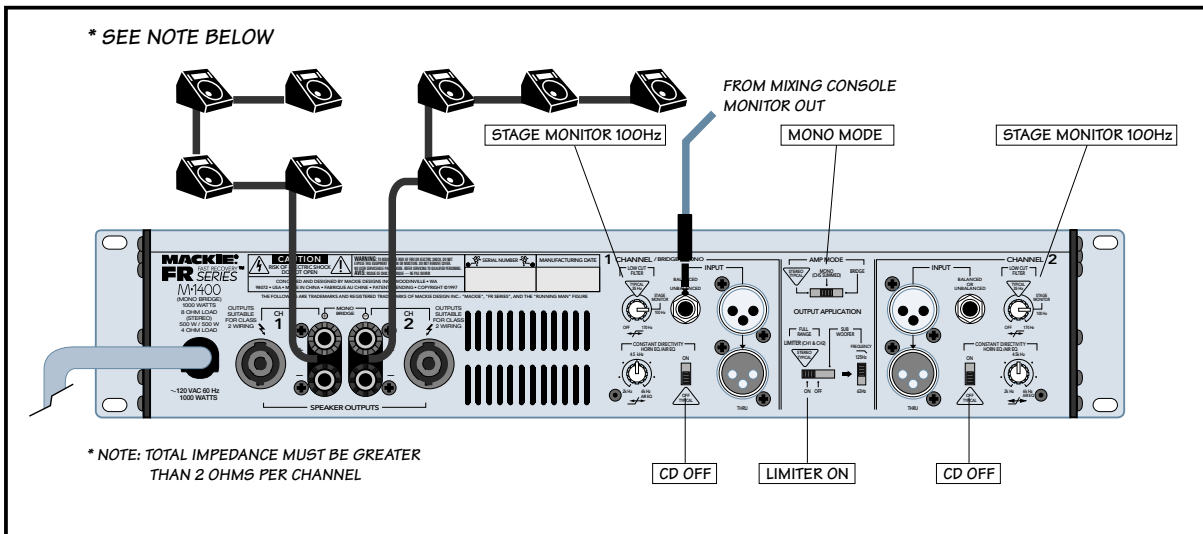

M•1400 EIGHT MONITOR SPEAKERS

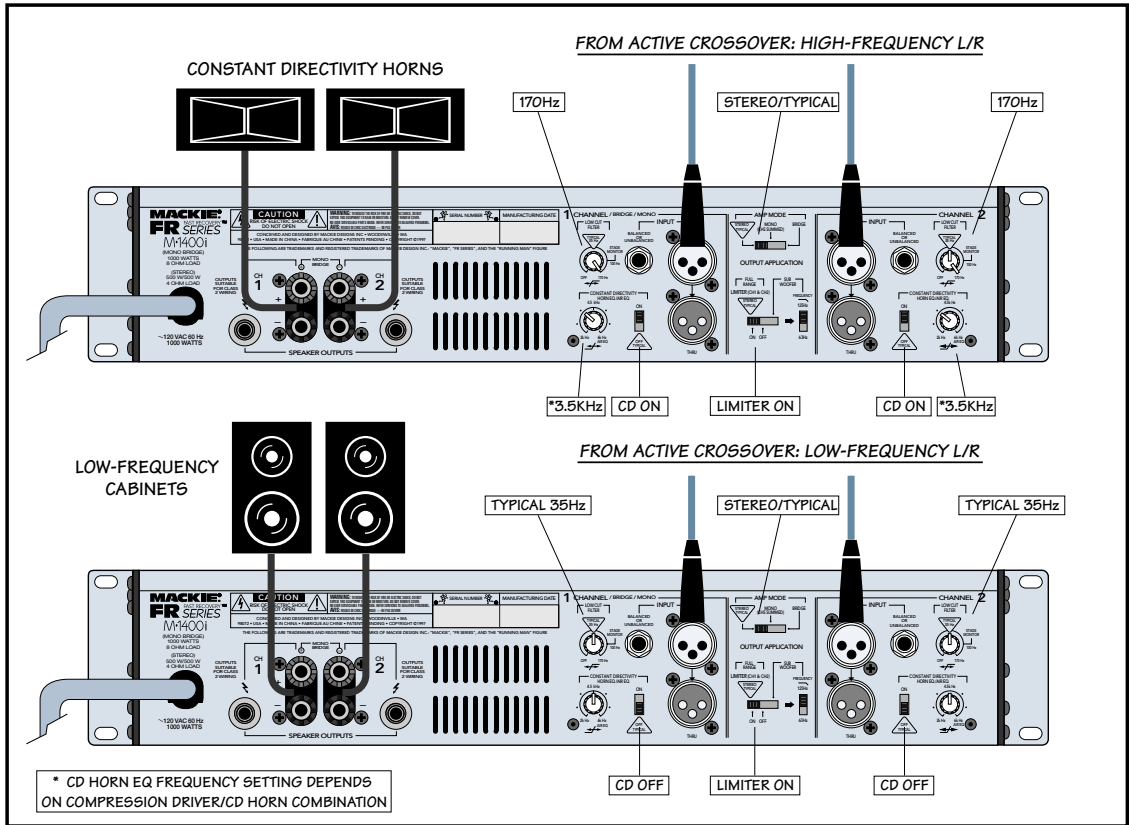

TWO M•1400i's: STEREO SYSTEM WITH CD HORNS

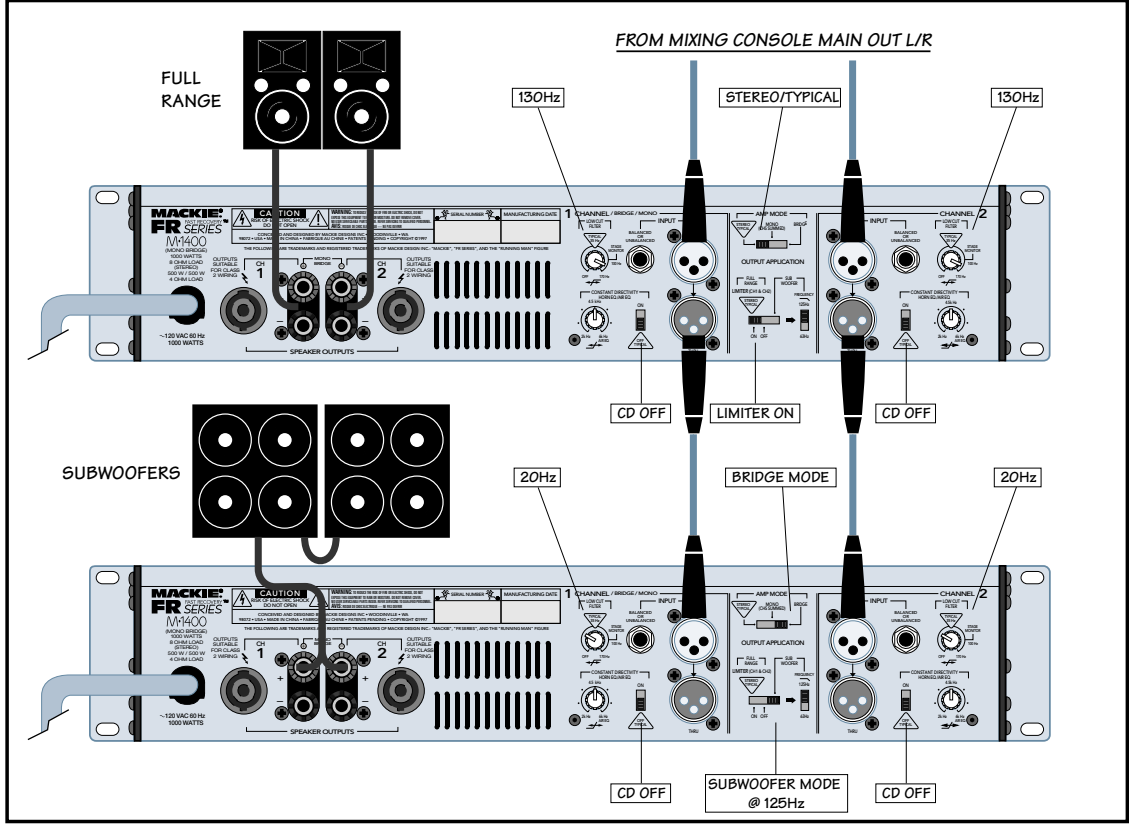

TWO M•1400's: STEREO SYSTEM WITH BRIDGED SUBWOOFER

FEATURE DESCRIPTIONS

1 GAIN

These giant knobs control the levels to the output section of the M•1400/M•1400i amplifiers. You'll notice that their travel is detented, meaning there are 40 built-in "resting points" so you can easily set both controls to the same level. Usually, these controls are set all the way up.

The gain structure of the amplifier is designed so that a +4 dBu (1.23V rms) input signal drives the amplifier to 425 watts into 4 ohms (41.23V rms @ 4 ohms = 425 watts). This is how the sensitivity of an amplifier is defined. In this case, it equates to a voltage gain of about 30 dB (okay, 30.51 dB for those of you sittin' there with your calculator!).

The graphics around the knob depict two different methods for setting the gain. The inner circle is marked in dB, calibrated from off (∞) to 30. This represents the amount of voltage gain from input to output. When using professional equipment with +4 dBu output levels, set the **GAIN** control all the way up to 30.

The outer circle is labeled in volts, with indications of 1V, 2V, and 3V. These correspond to the input sensitivity of the amplifier. With the **GAIN** control all the way up (fully clockwise), the input sensitivity is 1.23V, which works well with professional equipment operating at a nominal +4 dBu level.

On the other hand, you may want your listening level to be quieter than the M•1400/M•1400i's maximum level. For instance, if you're using the M•1400/M•1400i as a control room amp, and your control room is the size of a telephone booth, you'll probably never want to hear the amp at its maximum level.



You can set the **GAIN** controls as low as you like. However, reducing the **GAIN** controls requires an increased input level to reach full power at the amplifier's output. See the sidebar "Constant Gain vs. Constant Sensitivity" for a better understanding of how this works.

Like all amplifier controls, you'll typically determine the optimal settings during installation or sound check, then leave them alone, using your signal source (usually a mixer) to control listening levels as you work. Or play.

Constant Gain vs. Constant Sensitivity

There are two viewpoints, or philosophies, regarding the gain structure of power amplifiers — constant gain and constant sensitivity.

Constant gain means that regardless of the output power of the amplifier, the gain from input to output remains the same. (By the way, this refers to the full gain of the amplifier, with the gain or level controls all the way up.)

Within a product line of constant gain power amplifiers, as the output power rating of an amplifier increases, the level of the input voltage must also increase.

For example, if an amplifier is rated at 100W into an 8-ohm load, and it has 26 dB of gain, it requires an input signal of 1.4V rms to drive it to full power. This is about +5 dBu, a reasonable operating point for professional gear.

Now take an amplifier rated at 200W into an 8-ohm load. If it also has a gain of 26 dB, it requires an input signal of 2.0V rms to drive it to full power, or +8 dBu.

This can become problematic as the power of the amplifier increases. What if you have a power amp rated at 800W into 8 ohms? This will require an input signal of 4.0V rms to drive it to full power. This equates to a whopping +14.3 dBu!! You've just robbed your mixer of 10 dB of headroom. You'll either have to have a good limiter to keep the transient peaks down, or turn down the level from the mixer and not use all the power available from the amplifier.

Constant sensitivity means that regardless of the output power of the amplifier, the input sensitivity of the amplifier (the input voltage required to attain full output power) remains the same. As the output power of an amplifier increases, the gain of the amplifier must also increase.

Referring back to the previous example, an amplifier rated at 100W into 8 ohms with a gain of 26 dB requires an input signal of 1.4V rms to drive it to full power. It has an input sensitivity of 1.4V rms. In order for the 200W amplifier to reach full power into 8 ohms with a 1.4V rms input signal, it must have a gain of 29 dB. And the 800W amplifier will require a gain of 35 dB to reach full power with a 1.4V input signal.

Continued on page 12

So what are the pros and cons of these two approaches? The reason some amplifier manufacturers use the constant gain approach is because the noise specification looks better. It's a fact of physics that as the gain of the amplifier increases, the circuit noise is amplified and increases too. By maintaining a constant gain, the noise spec for an 800W amplifier can look as good as the noise spec for a 100W amplifier. The downside to this is that you have to crank up your mixer level feeding the input of the amplifier, losing headroom and possibly increasing the noise level from the mixer (unless you have a Mackie mixer with low-noise VLZ circuitry!).

Conversely, constant sensitivity demands that as the power increases, so must the gain. Yes, the output noise of the amplifier will increase, but you maintain the critical headroom available from your mixer. The additional noise is generally not a problem in live sound reinforcement situations. If it is, you can turn down the **GAIN** control a few clicks to find a happy compromise between noise floor and headroom available. As an added benefit, you can drive multiple amplifiers with the same signal and get the maximum power available from all of them.

Mackie subscribes to the philosophy of constant sensitivity. Our amplifiers can be driven to full power with an input level of +4 dBu (1.23V rms).



You may wonder why we didn't use just one stereo control to control both sides. That's in case your application requires a left/right imbalance (due to an irregularly shaped room) or if you're using the two sides for completely different purposes (monitor in channel 1 and side-fill in channel 2, for instance). Besides, they look cool.

2 METERS

The M•1400/M•1400i's meters indicate the relative output level of the amplifier referenced to full power. The numbers next to the meter's LEDs are in dB below full power.

Ideally, the M•1400/M•1400i's -20, -9, -6, and -3 LEDs will flicker at normal signal levels, while the OL LED may flicker occasionally during peak moments.

OL is short for Overload. Overloading, or clipping, occurs when the output voltage no longer linearly follows the input voltage and simply stops. This causes a sine wave to "square off," or get "clipped off." Thus, the term clipping. Fear not — this scenario is quite unlikely. Even with the **GAIN** controls fully up, the M•1400/M•1400i amplifier easily accepts professional "+4 dBu" operating levels.



If the OL (Overload) LED is blinking frequently or continuously, turn down the source signal (i.e. the mixer's master faders).

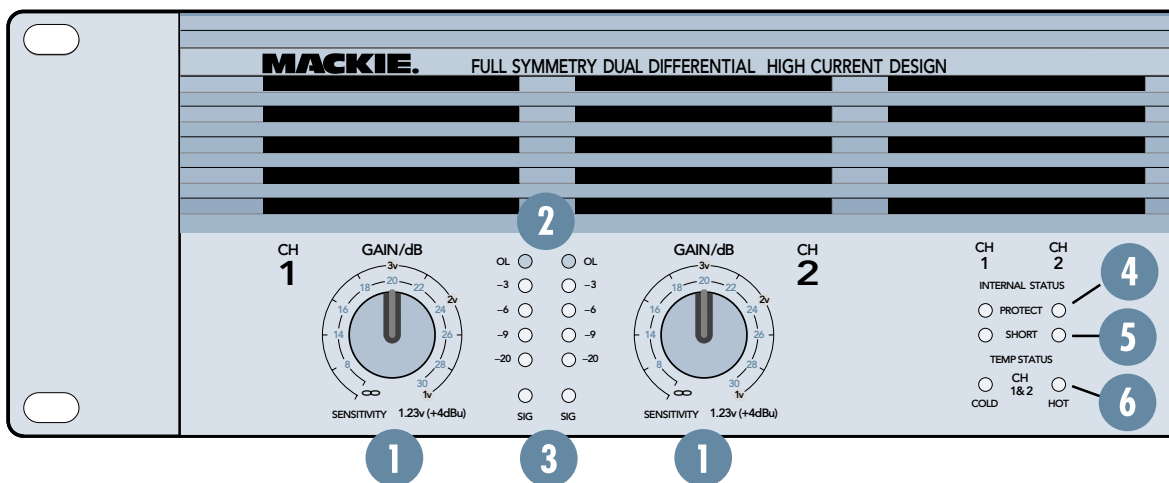

3 SIG

SIG (short for “signal present”) is the lowest step in the meters’ 2 ladder. It senses the signal prior to the GAIN control, so when SIG is lit, you know the M•1400/M•1400i is receiving signal. If it’s the only meter LED lit (meaning the other meter LEDs are not lit), the M•1400/M•1400i is receiving a very weak signal (below -20 dB).

4 PROTECT

If the PROTECT LEDs are on, the M•1400/M•1400i’s output section has shut down. That, of course, means you won’t hear anything until you rectify the situation. Three things can cause the PROTECT circuit to engage:

1. Powering up the M•1400/M•1400i. A built-in delay circuit saves your speakers (and ears) from the thumps or pops that can sometimes occur when powering up a system. During this 3 second delay, the PROTECT LEDs light up.
2. A short circuit (or near short) in either of the outputs. Both the PROTECT and the SHORT 5 LEDs light up.
3. The temperature in the M•1400/M•1400i has risen to an unsafe level. The PROTECT and the TEMP STATUS HOT LEDs 6 light up.



The M•1400/M•1400i amp draws its ventilation air in from the front and out through the side panels. The amp needs plenty of fresh air to stay cool. **DO NOT BLOCK THE VENTILATION PORTS.** See “Thermal Considerations” on page 23 for more details.

5 SHORT

If this LED comes on, the M•1400/M•1400i has detected a short circuit in either of the outputs, meaning that the hot (+) and cold (-) speaker wires are touching, or a speaker itself is shorted out. Such a condition causes the M•1400/M•1400i to engage its PROTECT 4 mode (when a signal is present), muting all signals at the amp’s outputs.

This short-circuit LED is a Mackie exclusive (until the other guys “borrow” the idea) and can save precious minutes of your troubleshooting time. Without it, you’d still have speaker and amp protection (via the PROTECT circuit), but you wouldn’t be able to determine the source of the problem. But with the SHORT LED, the M•1400/M•1400i comes right out and tells you!

WARNING: The SHORT LEDs indicate an unsafe condition for the power amplifier. When the short-circuit protection is activated, the SHORT LED lights, then the PROTECT LED lights and the SHORT LED turns off. After about four seconds, the protection circuit turns off and the amplifier resumes normal operation. If it senses the shorted condition again, the cycle repeats until you fix the problem.

Typical causes for a “short” indication would be either a shorted speaker cable or too many speaker cabinets connected to the amplifier (i.e., the load impedance is too low). If a “short” is indicated, please check your cables. If the cabling is OK, then reduce the number of cabinets driven by the amplifier.

Note: When using the amplifier in BRIDGE mode, one or both SHORT LEDs may light under shorted or low impedance conditions. Regardless of whether one or both LEDs light, it’s an indication of a problem that requires further investigation.

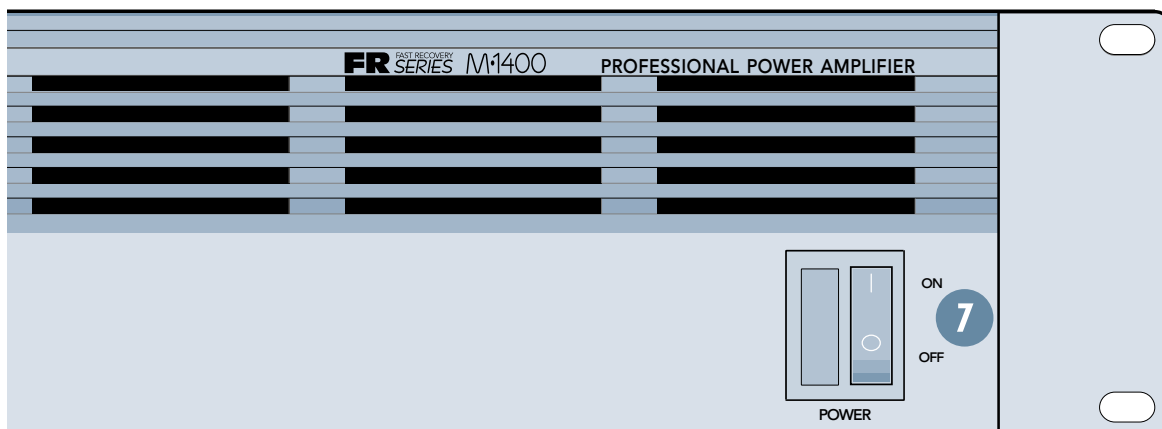

6 TEMP STATUS

TEMP (short for temperature) is another feature designed to keep your mind at ease. Normally the COLD LED is lit, indicating that the M•1400/M•1400i is working normally. Under extreme conditions the amplifier may overheat. You may ask, “What kind of extreme conditions?”

Overheating problems are usually caused by one of the following situations: improper ventilation, high ambient temperatures, overdriving the amplifier into clipping, driving the amplifier hard into low impedance loads, frayed or partially shorted speaker cables, or defective or internally shorted speakers.

The heaviest load the M•1400/M•1400i can tolerate is 2 ohms per channel (4 ohms in bridged mode). If you’ve got a set of speakers wired in parallel, be sure the load isn’t adding up to less than 2 ohms. Anything below 2 ohms can cause the SHORT 5 LED to light and trigger the PROTECT mode.



Remember: As the load gets “heavier,” its value in ohms goes down. For instance, a 2-ohm speaker load is twice as “heavy” as a 4-ohm load.

As the internal temperature of the amplifier rises, the fan kicks into high speed. This occurs at 60°C (140°F). More air moves through the constant temperature gradient cooling tunnel to remove additional heat from the output transistors. However, if the internal temperature of the amplifier should exceed 80°C (176°F), the COLD LED turns off, the HOT LED turns on, and both PROTECT LEDs shine. The output of the amplifier is muted — at this point the amplifier is in Standby mode and remains there until the internal temperature cools off to a safe level (55°C or 131°F). When this occurs, the HOT LED and PROTECT LEDs turn off, the COLD LED turns on and normal operation resumes.

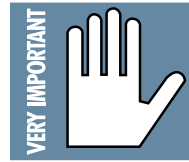

Be Aware: If the HOT LED comes on frequently, something is overworking the M•1400/M•1400i or it’s not properly ventilated. Look

at each of the “extreme conditions” described above and try to determine what is causing the amplifier to overheat. Refer to “Thermal Considerations” on page 23 or to the “Troubleshooting” section in *Appendix A* for more help.



What’s that? Why doesn’t the fan just go fast all the time? Well, if it did, you might actually hear it whirring during your quiet moments (there are quiet moments in your life, aren’t there?). While this whirring would be of no concern in most live-sound situations, it could become annoying in a control room environment. So, when the M•1400/M•1400i is not working hard, the fan goes slow; when the music gets loud and puts the amp to work, the fan goes fast.

7 POWER

To make the amp operate, push the top half of the POWER switch. It clicks into place and a soothing green light adjacent to it glows. To turn the amp off, push the lower half. It’ll click again and the green light will extinguish.

When you power up the M•1400/M•1400i, a built-in delay circuit prevents any pops or thumps from being transmitted to the speakers due to turn-on instability in the system. *Be sure the signal driving the amplifier is turned down when you first power up the system.* There are few things as rude as 3 seconds of silence followed by 250 watts of full-blast stereo sound! (Well, maybe 225 kilowatts of accordion music...)

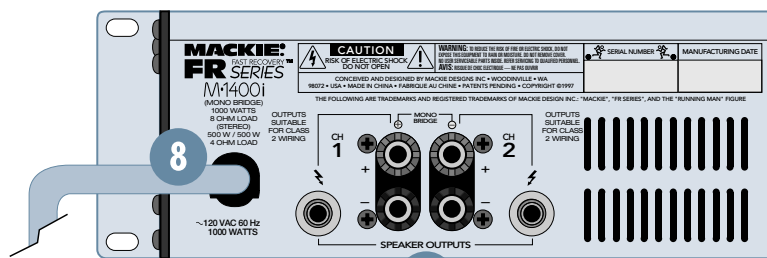
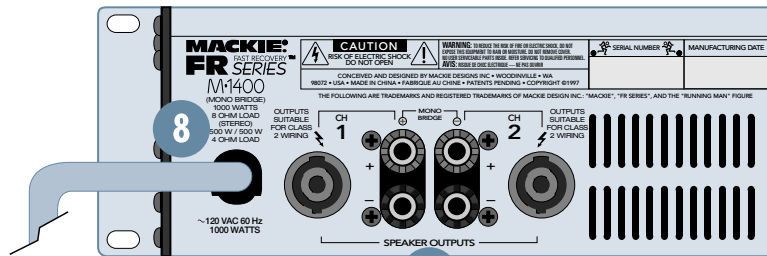



If you shut down your system, turn off your amplifiers first. When powering up, turn on your amplifiers last. This way, equipment feeding the amp won't "pop" or "thud" when it's powered up or down.

8 POWER CORD

We all know what a power cord is. The M•1400/M•1400i has a big beefy cord built in. Plug the power cord into an outlet that is capable of delivering the correct voltage for your model.



For current-delivery purposes, the M•1400/M•1400i's voltage source (wall outlet, extension cords, or power strips) must be capable of continuously delivering 15 amps (for 120V versions). And for safety reasons, that source must be a "3-prong" outlet with hot, neutral, and ground terminals. We're dealing with some big-time electricity here — don't mess with it. See "AC Power Considerations" on page 25 for more details.

9 SPEAKER OUTPUTS

Some call them "GR" jacks, others call them "Banana" jacks, but we prefer to call them "Binding Posts." You can call them whatever you like (except late for supper). These terminals are your standard fare.

To use the binding post outputs, you can terminate your speaker cables with single or double banana plugs, spade lugs, or leave them unterminated: Unscrew the amp's binding posts enough to reveal the holes on their sides, then insert your stripped wires (stripped about 3/8" back) into the holes and retighten the posts (finger tight is fine — please don't reef on them with a wrench!). Be careful that no runaway strands touch the chassis or other terminals.

The red posts are labeled "+," which means positive. The black posts are labeled "—" for negative. You probably know the importance of getting these terms correct — if one side is hooked up "in phase" and the other side is "out of phase," you'll be "out of work." (By the way, although everyone says "phase" in this situation, the correct word is "polarity"... but it's not as much fun to say.)

Using high-quality stranded speaker cable (16 gauge or thicker), connect the positive outputs of the M•1400/M•1400i to the positive inputs of your speakers, and the negative outputs to the negative inputs. The exception: If you're using the M•1400/M•1400i in BRIDGE 18 mode, this does not apply, (see BRIDGE on page 22).

In addition to the binding posts, the M•1400i also has 1/4" TS (tip-sleeve) SPEAKER OUTPUTS, so you can use speaker cables with 1/4" TS plugs. The tip is positive (+) and the shield is negative (-). They're wired in parallel with the binding posts and behave exactly the same (except they can't be used in BRIDGE 18 mode).

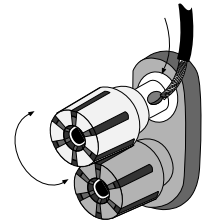

Bare Wire

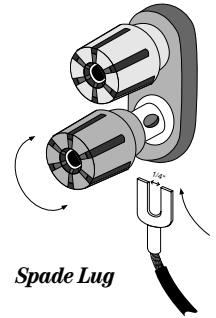

Spade Lug

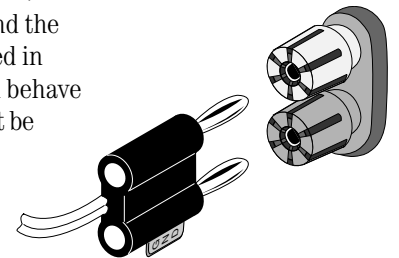

Double Banana Plug

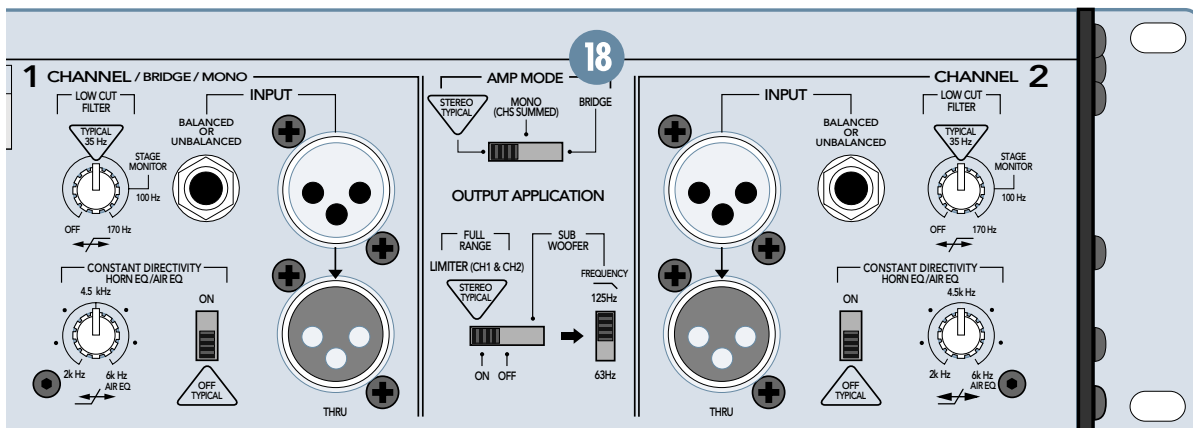

In addition to the binding posts, the M•1400 has Speakon® connectors for connecting the speakers to the amplifier. These are locking connectors that are easy to attach and are designed to handle high power levels into low-impedance loads. These connectors have become popular with many loudspeaker manufacturers because they provide a quick, yet safe and secure method of connecting speaker cables.

Speakon connectors have a twist-locking mechanism that prevents them from being pulled out accidentally. Pin 1+ is positive (+) and Pin 1- is negative (-).

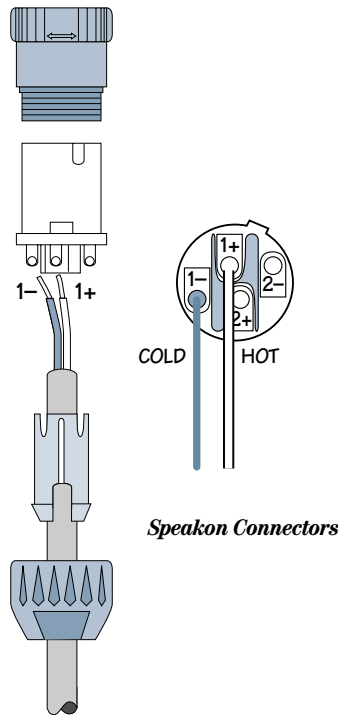

Before making connections to an amp or reconfiguring an amp's signal routing, turn the amp's **GAIN 1** controls down, turn the **POWER 7** off, make the changes, turn the **POWER** back on, and then turn the **GAIN** controls back up. Although the M•1400 amplifier can handle "opens" (no connection) and "shorts" (positive and negative signal lines in direct contact), you don't want the speaker ends of live cables to zap every piece of equipment they touch as they're being dragged across the stage.



Ordinarily, applying a positive voltage to a speaker's positive input and negative voltage to the negative input results in an outward excursion of the woofer. But some woofers are built with reverse polarity, meaning that the above conditions result in an inward excursion.

If you're not sure which type of speakers you have, take a look at their literature. If you're still not sure, here is a simple test: take a 1.5V flashlight battery and connect the positive terminal of the battery to the positive (+) input of the speaker, and connect the negative terminal of the battery to the negative (-) input of the speaker. Observe the motion of the speaker cone. It should move out when voltage is applied, and return to rest when voltage is removed. Make sure all the speakers in the system move in the same direction (there are a few exceptions — some speakers are deliberately designed with reverse-polarity woofers).

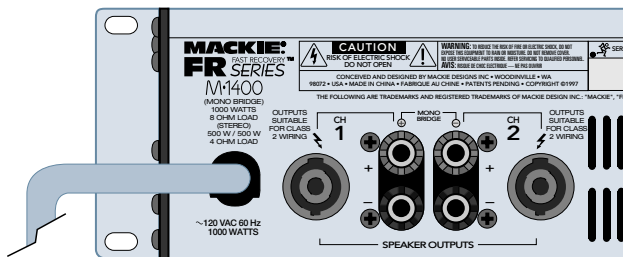

10 INPUT

The M•1400/M•1400i amplifier gives you a choice — it has the traditional XLR inputs, as well as 1/4" TRS (tip-ring-sleeve) input jacks. Sonically (and electrically) they're identical, so choose either one. Since these two inputs are in parallel (the **THRU 11** jacks are in parallel with the inputs as well), you shouldn't connect more than one source to the **SIGNAL INPUT** jacks. Each can be used with either balanced or unbalanced signals.

When connecting a balanced signal using the XLR or 1/4" jacks, they're wired thusly, per AES (Audio Engineering Society) standards:

	<u>XLR</u>	<u>TRS</u>
Hot (+)	Pin 2	Tip
Cold (-)	Pin 3	Ring
Shield (Ground)	Pin 1	Shield

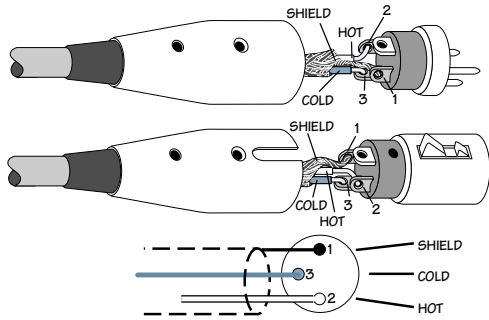

Balanced XLR Connectors

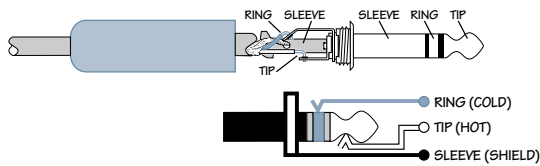

Balanced 1/4" TRS Plug

Unbalanced TS (tip-sleeve) lines can be accommodated via the TRS jack. Make sure the cord terminates with a TS plug (like a guitar plug), or if it's a TRS plug (like a headphone plug), make sure the ring is tied to the shield, preferably at the source.

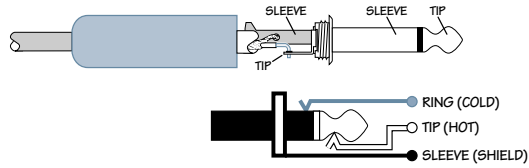

Unbalanced 1/4" TS Plug

You can connect an unbalanced XLR cable to the M•1400/M•1400i, although this would be unusual — as unusual as an unbalanced XLR output.

The M•1400/M•1400i amp expects to see a nominal signal level anywhere between the -10dBV “semipro” and +4 dBu “pro” standards, meaning almost any line-level mixer or other device can be plugged into the amp’s INPUTS. Use the **GAIN 1** controls to adjust the gain of the amplifier to match the signal level you’re using.



If you set the AMP MODE **15** switch in MONO or BRIDGE, use the CHANNEL 1 inputs only — the CHANNEL 2 inputs are disabled in this case.

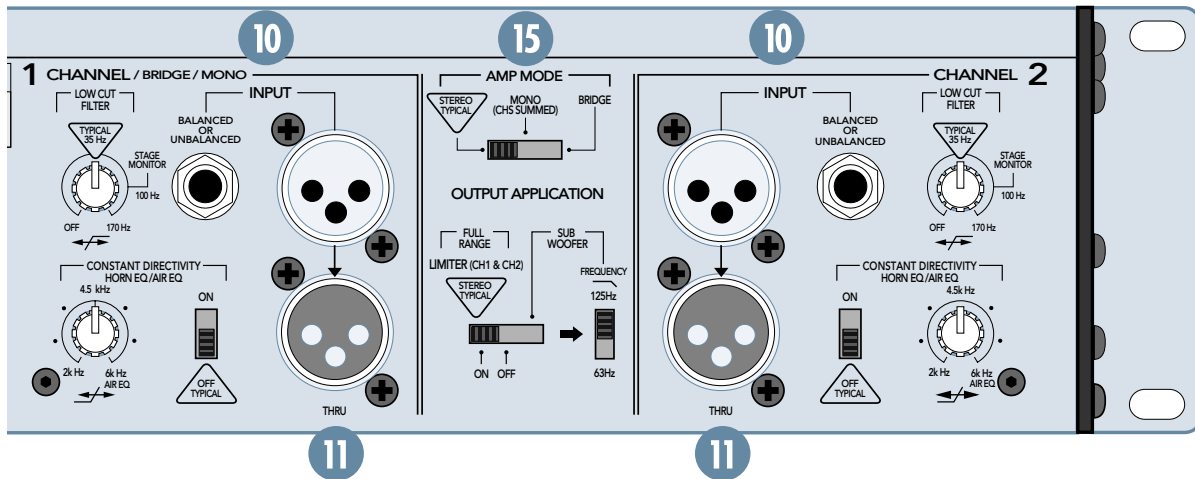

11 THRU

Someday you'll do a show at Carnegie Hall and realize that one M•1400/M•1400i amplifier is just not going to do the job — you'll need a six-foot-high rack full of 'em. That's what the THRU jack is for. Simply plug the signal source outputs into the first amp's INPUTs 10, patch from that amp's THRU jacks to the next amp's INPUTs, and so on, daisy-chaining as many amps as you can afford (assuming your console has low-impedance outputs).



A general rule of thumb is to maintain a load impedance 10 times or more than the source impedance to prevent excessive loading. If your console has an output impedance of 100 ohms, then you can daisy-chain up to twenty M•1400/M•1400i amplifiers, which presents a load of 1000 ohms to the console (input impedance of 20 kohms divided by 20 amplifiers = 1000 ohms).

The THRU jacks can also be used to relay the signal on to other devices such as a DAT or cassette recorder, enabling you to record exactly what the audience is hearing. The THRU jacks are wired straight from the XLR and TRS INPUTs 10 — there is no electronic circuitry between — so the signal going into the amp is exactly the same as the signal coming out of the THRU jacks.



You can use the THRU jack as an input, if necessary, since it's wired in parallel with the other input connectors. You can also use the 1/4" TRS INPUT jacks as THRU jacks. Simply connect the 1/4" TRS INPUT jacks on the first amplifier to the TRS 1/4" INPUT jacks on the second amplifier using 3-conductor shielded cables with TRS plugs on both ends.

Warning: If you use a regular guitar cord with 2-conductor TS plugs, you'll unbalance the signal at the XLR input by grounding the low side (–) of the signal (pin 3).

12 LOW CUT FILTER

Every woofer has frequency response specifications. It's usually expressed in Hertz (or cycles per second), like "40Hz–300Hz." The "40Hz" refers to the low-frequency point (usually, but not always) where the speaker's output drops by 3 dB, and will "roll off" completely as the frequency goes down. There is no point in sending a woofer any frequencies it

can't reproduce — you can't hear it, and worse yet, it's a waste of amplifier power that can be better used reproducing frequencies you *can* hear.

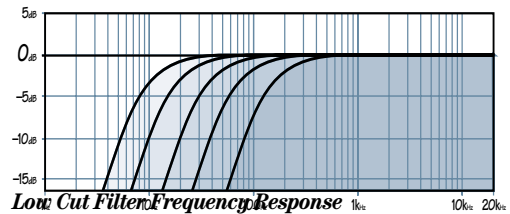

In order to match the output bandwidth with your particular speaker system, the M•1400/M•1400i amplifier has a tunable LOW CUT FILTER 12. The frequencies are clearly marked along the knob's travel :

- Fully counterclockwise, the frequency is below 10Hz, effectively bypassing the filter.
- Center detent is 35Hz and labeled TYPICAL, since precious few woofers actually go below that.
- 3/4 of the way up is labeled STAGE MONITOR, 100Hz, perfect for, well, stage monitors (they seldom reproduce below 100Hz; besides, it prevents low-frequency "leakage" into the house).
- Fully clockwise is labeled 170Hz.

So, grab your woofer's spec sheet and find the low roll-off spec. Then set the M•1400/M•1400i's LOW CUT FILTER 12 at the same frequency.

If you do this correctly (and make sure the meters 2 are happy), you'll never again see your woofer moving sporadically without audible signal. Your system will play louder and cleaner, and you may never blow another woofer again!

13 CONSTANT DIRECTIVITY

Compression drivers mounted on constant-directivity horns require compensation, in the form of a high-frequency boost, with its "knee" set somewhere between 2kHz and 6kHz. Until now, you'd have to resort to external crossovers or worse yet, graphic EQ modules. Both of these are fraught with limitations, not to mention adding cost, rack space requirements and complexity to your system.

The M•1400/M•1400i Power Amplifier eliminates the need for any of these external devices — they have the compensation circuitry already built in. And using it is a breeze.

14 CD Frequency

Your compression drivers' spec sheet should have a suggested frequency for compensation boost. If so, just turn the **CONSTANT DIRECTIVITY** switch **ON** and set its knob to match that frequency. If your spec sheet doesn't have that information, you can simply adjust the Frequency knob by ear, preferably using the same music as the actual performance (3.5kHz is a good place to start).

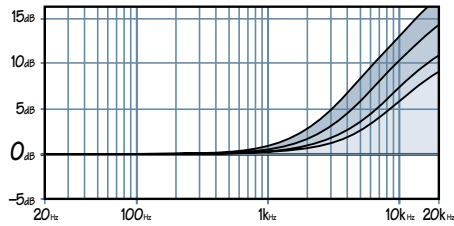

Constant Directivity EQ

Wait, there's more: If you don't have constant directivity horns, you can forget all this, and leave the switch **OFF**.

Or, better yet, you can use this **CONSTANT DIRECTIVITY** feature to enhance your EQ curve. By setting the Frequency knob fully clockwise, you introduce a very high frequency boost to the signal (above 6kHz). And in Mackie-land, this gentle boost has a name: **AIR**, as seen on our SR series of consoles. By boosting these high frequencies, **AIR** will breathe life into your mix, making cymbals brighter and vocals silkier.

Speaking of Mackie SR consoles: If you use both the **AIR** feature on an SR console as well as the **AIR** feature just described on the M•1400/M•1400i, you may be overdoing it. You won't hyperventilate or anything, but it might cause your audience to experience ear fatigue from too much high-frequency content. Too much of a good thing, perhaps.

More on Constant Directivity Horns



Back in the early '70s, radial horns were the common mechanism for reproducing high frequencies. Radial horns had a serious problem, though. The high frequencies

tended to beam straight ahead, so if you moved away from front and center (off-axis), the brilliance and sizzle quickly diminished to a muffled blur. Constant Directivity horns were designed to spread the higher frequencies evenly throughout the horn's dispersion pattern.

This was accomplished by using a smaller opening to the horn, using straight sidewalls in both the horizontal and vertical planes (radial horns typically have curved vertical sections that cause beaming), and providing a flare at the mouth of the horn to disperse the mid to high frequencies.

All high-frequency compression drivers have an inherent roll-off of about 6 dB per octave above about 3kHz. The exact frequency at which the roll-off occurs (called the mass breakpoint) depends on the materials used, the mass of the moving parts (diaphragm and voice coil) and the strength of the magnet. The **CONSTANT DIRECTIVITY HORN EQ** control on the M•1400/M•1400i compensates for this natural roll-off in the power response of the compression driver coupled to a CD horn, with the end result of flat-frequency response (constant) with a wide coverage angle (directivity).

15 AMP MODE

This three-way switch, along with the **OUTPUT APPLICATION**'s 19 three-way switch, determines what kind of amplifier you want the M•1400/M•1400i to be (or not to be — what was the question?).

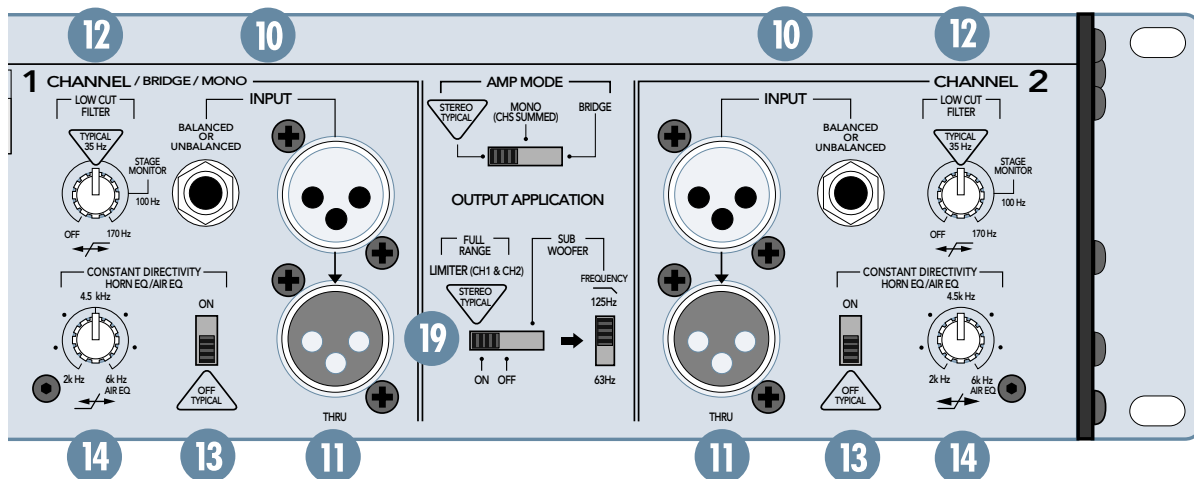

The AMP MODE switch determines the input signal routing within the M•1400/M•1400i amplifier. Shipped from the factory, the switch is set to STEREO. This is correct for about 90% of the applications using an amp like this (hence the TYPICAL indicator near it). But you may be in the 10% bracket, requiring special input routing within the amp.

AMP MODE should be configured before operation — if you must change it during performance, turn down the GAIN 1 controls as a precaution to protect the speakers from any inadvertent pops or thumps.

STEREO 16 mode (separate left and right inputs, separate left and right outputs) is the typical setup for amplifying stereo signals.

MONO 17 mode (sometimes called Dual-Mono — one mono input, two mono outputs) is for sending a mono signal to two different speaker sets, with separately-adjustable GAIN 1 controls.

BRIDGE 18 mode (sometimes called Bridged-Mono — one mono input, one mono output) uses both sides of the amp to double the power to one speaker set. With two M•1400/M•1400i power amplifiers, each set to BRIDGE mode, you can deliver as much as 1400 watts per amplifier.



If you set the AMP MODE 15 switch to MONO or BRIDGE, use the CHANNEL 1 inputs only — the CHANNEL 2 inputs go nowhere in this case.

Note: There is one exception to this rule. If you have the OUTPUT APPLICATION switched to SUBWOOFER, the inputs to Channels 1 and 2 are summed regardless of the AMP MODE setting (see 21). Also, BRIDGE 18 mode requires special connections at the SPEAKER OUTPUTS 9.

18 BRIDGE

In STEREO mode, the M•1400/M•1400i Power Amplifier can deliver 700 watts per side into 2 ohms. If that's not enough, you can use two M•1400/M•1400i's, each in BRIDGE mode, and deliver 1400 watts per amplifier into 4 ohms. Or, you can use one amp in BRIDGE mode to power a monaural system. Finally, BRIDGE mode is also popular for subwoofer applications — but please see SUBWOOFER 21 on the next page for a special subwoofer surprise.

To use all the M•1400/M•1400i's power to drive one speaker cabinet using BRIDGE mode, you'll have to do four things:

1. Turn off the power to the M•1400/M•1400i.
2. Set the AMP MODE 15 switch to BRIDGE.
3. Connect the positive side of the speaker cable to the Channel 1 red (+) binding post.
4. Connect the negative side of the speaker cable to the Channel 2 red (+) binding post.
5. (Okay, make that five things!) Use only the CHANNEL 1 INPUT 10 (unless you're using the SUBWOOFER OUTPUT APPLICATION).

The CHANNEL 1 GAIN control adjusts the output level of the amplifier. The CHANNEL 2 GAIN control has no effect.

Once again: Before making connections to an amp or reconfiguring an amp's routing, turn the power off, make the changes, then turn the power back on.

19 OUTPUT APPLICATION

The OUTPUT APPLICATION switch should be configured before you turn on the amplifier. This switch allows you to choose between three different configurations:

LIMITER ON (TYPICAL). This is the normal configuration: full-bandwidth audio with protective limiting (please see 20).

LIMITER OFF is also full bandwidth audio, but without protective limiting (please see 20).

SUBWOOFER mode, with built-in low-pass filter, no protective limiting (please see 21).

20 LIMITER

The LIMITER is not designed to alter your sound — it's just there to protect your speakers from clipping. Its effect is virtually transparent, meaning you probably won't even notice any audible difference. We recommend that you leave it engaged (via OUTPUT APPLICATION 19), hence the TYPICAL label below it.

If you're working at quiet levels all the time, or you've already placed a compressor/limiter in the signal path, or if you just hate compression, you can leave the LIMITER out of the circuit (via OUTPUT APPLICATION 19).



The LIMITER is channel independent; that is, it works independently on each channel. It senses when the amplifier channel is about to be overdriven and attenuates the overall level just enough to keep the signal from clipping. Clipping occurs when the output voltage no longer linearly follows the input voltage and

simply stops. This causes a sine wave to “square off,” and the average power going into the speaker is roughly double that of a sine wave. Square waves sound awful, and could possibly damage your speakers and/or your reputation.

The LIMITER is especially handy when you’re working with loud output levels. Having the signal spikes (kick drum, for instance) attenuated a bit can actually increase the apparent loudness of the overall mix without diminishing the “power” behind the spikes.



Be Forewarned: With the LIMITER engaged, you can still overdrive the amplifier into clipping and cause distortion. It just takes a stronger signal to do it. So even with the LIMITER turned on, you should still pay attention to the OL LEDs 2.

21 SUBWOOFER

Here’s a special surprise: If you bought the M•1400/M•1400i amplifier to power a subwoofer system, you just saved yourself the cost of a crossover! The M•1400/M•1400i amp has an active SUBWOOFER filter built in. You can use it, along with the variable LOW CUT FILTER 12 in a second M•1400/M•1400i, to reproduce the function of a crossover.

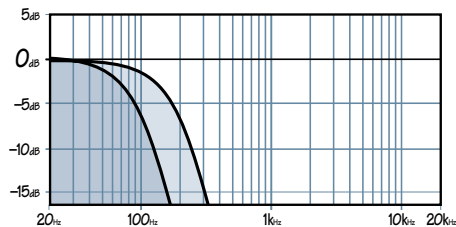

Subwoofer Filter

Since most low-frequency energy is mono- phonic (the same in both channels), the subwoofer circuit takes the signal from both Channels 1 and 2 and sums them together. This summed signal is then directed to both power amplifier output stages. It doesn’t matter whether the AMP MODE 15 switch is set to STEREO, MONO, or BRIDGE, it will sum the inputs when the OUTPUT APPLICATION switch is set to SUBWOOFER.

Here’s how to configure it:

1. Turn the M•1400/M•1400i’s POWER 7 off.
2. Set the OUTPUT APPLICATION 19 switch to SUBWOOFER.
3. Select a rolloff point, via the FREQUENCY 22 switch: At “125Hz,” you’ll get the low sub-harmonics on up to the audible bass range. At “63Hz,” you’ll get just the lowest frequencies, more to be felt than heard. You’ll probably want to try this switch both ways.
4. Make sure the LOW CUT FILTER is set to OFF or nearly OFF. If it is turned up above the subwoofer cutoff frequency, the output from the amplifier will be greatly diminished.
5. Connect your cords and speaker cables as usual (see “Quick Start” on page 4). Set the AMP MODE 15 to either STEREO, MONO, or BRIDGE, depending on your application. (STEREO and MONO operate the same with SUBWOOFER activated).
6. Turn the M•1400/M•1400i’s POWER on. **Woof!**

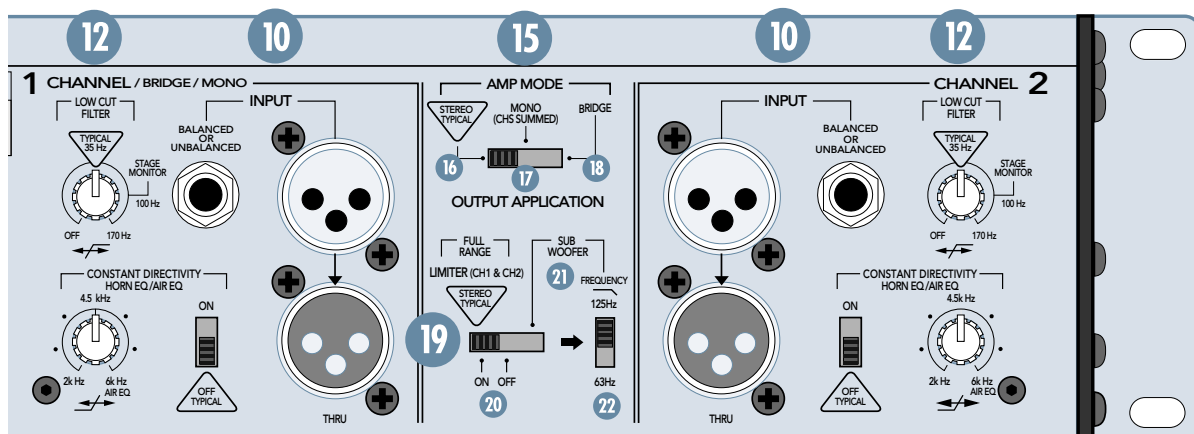

If you want to use a second M•1400/ M•1400i to reproduce the rest of the audio range, follow this procedure:

1. Connect the THRU 11 jacks on the first subwoofer amplifier to the INPUT 10 jacks on the second amplifier.
2. With POWER off, set the OUTPUT APPLICATION 19 switch on the second amplifier to FULL RANGE (LIMITER either ON or OFF).
3. Set the LOW CUT FILTER 12 frequency control to either 63Hz or 125Hz, depending on the cutoff frequency selected in the subwoofer amplifier 22.

Since these exact frequencies are not labeled on the amplifier, you can guesstimate the position of the knob. 63Hz is located at about 1 o'clock and 125Hz is about 4 o'clock.

If you want to be really accurate, you will need to use a variable-frequency signal generator along with a frequency counter and a voltmeter or oscilloscope to find the exact position for the knob. The voltmeter or o'scope should be capable of measuring low frequencies accurately (down to 60Hz).

1. Connect the signal generator to the INPUT 10 of the amplifier and monitor the SPEAKER OUTPUT 9 with the voltmeter or o'scope.
2. Adjust the signal generator level so you measure 1V rms output at 1kHz. (You should turn down the GAIN knobs on the amplifier about halfway.)
3. Change the frequency of the signal generator to 63Hz or 125Hz, whichever you're using as your subwoofer crossover frequency. You may need to use a frequency counter for accuracy.
4. Adjust the LOW CUT FILTER 12 frequency control until the voltmeter or o'scope reads 0.707VAC rms. This is the -3 dB point, and means you have now matched the LOW CUT FILTER frequency cut-off point to the SUBWOOFER FREQUENCY switch setting (either 63Hz or 125Hz).

After you've completed this exercise, you should mark the position of the control with a stick-on arrow or label so you don't have to repeat it should the control accidentally get moved.



GENERAL PRECAUTIONS AND CONSIDERATIONS

RACK MOUNTING

The M•1400/M•1400i amp requires two rack space units (2 IU = 3.5"). It also requires 16.25" (M•1400) or 16.38" (M•1400i) depth inside the rack, including the rear supports. When designing your rack, put the heavier items at the bottom and the lighter items toward the top.

Secure the front panel of the amplifier to the front of the rack using four screws with soft washers to prevent scratching the panel. In addition, because of the weight of the amplifier, you must secure the rear support brackets of the amplifier to the back of the rack. You could use a support rail or shelf across the back of the rack, or angle brackets attached between the rear support brackets and the rear rails of the rack. This is recommended for all components mounted in a rack that is going to be moved frequently (or thrown in the back of a pickup truck and transported down a bumpy gravel road to that outdoor festival!).

THERMAL CONSIDERATIONS

The M•1400/M•1400i amp is fan-cooled and brings air in through the front and out through the sides. Make sure that cool air is available at the front of the amplifier, and that there is room on each side for the warm air to exit from the amplifier and dissipate. If rack-mounted, make sure there is room for the warm air to circulate around the side and out through the rear of the rack. In a typical rack, there will be a space of 1 to 2 inches on either side of the amplifier. This is adequate to allow the warm air to exit from the amplifier.

The M•1400/M•1400i's unique T-Design Constant Gradient Cooling Tunnel provides substantially better cooling for the output transistors than conventional designs that simply blow air through the chassis, getting dust and other contaminants over all the internal components. The Cooling Tunnel provides a shorter, more directed path so the cool air concentrates on the heat produced by the output devices. This results in increased reliability and longevity for the amplifier.

AC POWER CONSIDERATIONS

Be sure the M•1400/M•1400i is plugged into an outlet that is able to supply the correct voltage specified for your model.

If the line voltage should drop below about 97% of the rated voltage, the M•1400/M•1400i will no longer be able to supply rated power. (It will continue to operate down to 50% of the rated line voltage, but it just won't be able to reach full rated power.)

Be sure the AC outlet can supply enough current to allow full power operation of all the amplifiers plugged into it. The outlet should be a socket that matches the power cord.

WARNING: Bypassing the plug's ground pin can be dangerous. *Don't do it!*

The AC current demand of an amplifier varies depending on several factors, including the crest factor and the duty cycle of the program material. Under typical conditions reproducing rock music where musical peaks are just below clipping, the M•1400/M•1400i requires the following average currents:

Amplifier Loading	Average Current Required		Peak Current Required	
	120V	240V	120V	240V
	2 ohms per side or 4 ohms bridged	8A	4A	25A
4 ohms per side or 8 ohms bridged	5A	2.5A	16A	8A
8 ohms per side or 16 ohms bridged	3.2A	1.6A	10A	5A

It is recommended that a stiff supply of AC power be used because the amplifier places high current demands on the AC line. The more power that is available on the line, the louder the amplifier will play and the more peak output power will be available for cleaner, punchier bass.

Under typical conditions, reproducing rock music where musical peaks are just below the clipping point, you can safely connect more than one amplifier to an AC service. Use the table below as a guideline:

Amplifier Loading	Maximum Number of Amplifiers on a 120V/15A Service (or 240V/7.5A Service)
2 ohms per side or 4 ohms bridged	2
4 ohms per side or 8 ohms bridged	3
8 ohms per side or 16 ohms bridged	5

Due to in-rush current, you should avoid turning them all on at the same time. Rather, sequence them on, one at a time, to prevent popping the circuit breaker.

The extension cord used to supply power to the “amp rack” should have a third wire safety ground to avoid presenting a safety hazard. We also recommend using a cord that has conductors large enough to avoid severely limiting the amplifier’s ability to supply high currents on transients.



Power amplifiers can have momentary peak current requirements many times above the nominal average current draw. According to Ohm’s Law, the greater the resistance of the linecord, the more input power is lost between the AC outlet and the power amplifier (across the linecord). And to further aggravate the matter, this relationship is nonlinear. The amount of power lost across the linecord increases exponentially as the current demand increases. So if the current demand doubles momentarily because of an exceptionally loud bass note, the amount of AC input power lost across the linecord increases four times. You can see that it is very important to keep the resistance of the linecord to a minimum. That’s why we recommend using a heavy gauge extension cord (like 14 gauge or bigger). Remember, wire gets thicker as the gauge number gets smaller (10 gauge is thicker than 14 gauge).

AC Power Distribution

In order to minimize ground loops, the safety grounds for all the outlets should be connected to a common (“star”) grounding point, and the distance between the outlets and the common grounding point should be as short as possible.

If lighting is used in a show, it is preferable to power the lights from a different AC circuit than the one powering the audio equipment. This will help minimize noise from the lights coupling into the audio (particularly if SCRs are used).

INPUT WIRING

Use a high-quality 3-conductor shielded cable to connect the signal between the signal source (mixing console, equalizer, etc.) and the balanced inputs to the amplifier. If you’re using the unbalanced inputs, use a high-quality 2-conductor shielded cable. Your Mackie Dealer can recommend a suitable cable for your application.

OUTPUT WIRING

Use heavy gauge, stranded wire for connecting speakers to the M•1400/M•1400i amplifier’s **SPEAKER OUTPUT 9** terminals. As the distance between the amplifier and the speakers increases, the thickness of the wire should also increase. Speaker wire has resistance, and when electricity passes through a resistor, power is lost. The thicker the wire, the less resistance it offers, and the more power actually gets to the speakers.

The thickness of wire is rated in gauges. Use the chart below to determine the correct gauge of wire to use according to the distance between the speakers and the amplifier, and the impedance of the load the amplifier is driving. This ensures that the power lost across the speaker wire is less than 0.5 dB.

Wire Length	Load Impedance	Gauge of Wire
Up to 25 ft.	2Ω	14 gauge
	4Ω	16 gauge
	8Ω	18 gauge
Up to 40 ft.	2Ω	12 gauge
	4Ω	14 gauge
	8Ω	18 gauge
Up to 60 ft.	2Ω	10 gauge
	4Ω	12 gauge
	8Ω	16 gauge
Up to 100 ft.	2Ω	8 gauge
	4Ω	10 gauge
	8Ω	14 gauge
Up to 150 ft.	2Ω	6 gauge
	4Ω	8 gauge
	8Ω	12 gauge
Up to 250 ft.	2Ω	4 gauge
	4Ω	6 gauge
	8Ω	10 gauge

70V DISTRIBUTION SYSTEMS

A distributed sound system uses a constant-voltage, high-impedance network that feeds a number of tapped transformers which, in turn, deliver power to individual speakers. Each tap is rated in watts, so you can select the amount of power delivered to the speaker. Developed for distributed paging and public address systems, one benefit of such a system is that it eliminates complicated impedance calculations when setting up a multi-speaker system. You just add up the total wattages of all the speakers in the system and make sure that it doesn't exceed the total power rating of the amplifier (allowing at least 10% for insertion losses). Another benefit is that by using high voltage and low current, losses in the speaker distribution wiring are kept to a minimum. Standard voltage levels include 25V, 70V, and 100V, but 70V systems are most commonly used in commercial sound distribution systems.

Because of the high power capability of the M•1400/M•1400i amplifier, it can be used to directly drive 70V constant-voltage distribution systems without the use of a step-up transformer. When the M•1400/M•1400i amplifier is operated in BRIDGE 18 mode, it can produce 850 watts into 8 ohms, or 82.5V. This is slightly higher than the standard 70.7V for which the system was designed. You can recalculate the actual power delivered to each tap by multiplying the tap's rated wattage by a correction factor (K). The correction factor is P_1/P_2 , where P_1 is the power delivered by the amplifier into 8 ohms (BRIDGE mode), and P_2 is the power delivered by 70.7V into 8 ohms (625W).

M•1400i: $K = 850W/625W = 1.36$. Thus, a 2.5W tap becomes 3.4W, a 5W tap becomes 6.8W and a 10 W tap becomes 13.6W.

CAUTION: A characteristic of many tapped transformers is that they saturate at very low frequencies, which causes their impedance to decrease, approaching the DC resistance of the copper wire. This can result in overloading the amplifier if the signal contains lots of low frequencies. When using an M•1400/M•1400i amplifier in a 70V distribution system, set the LOW CUT FILTER 12 to 100Hz or higher. In addition, install an RC network at the SPEAKER OUTPUT 9 of the amplifier, as shown in the figure below.

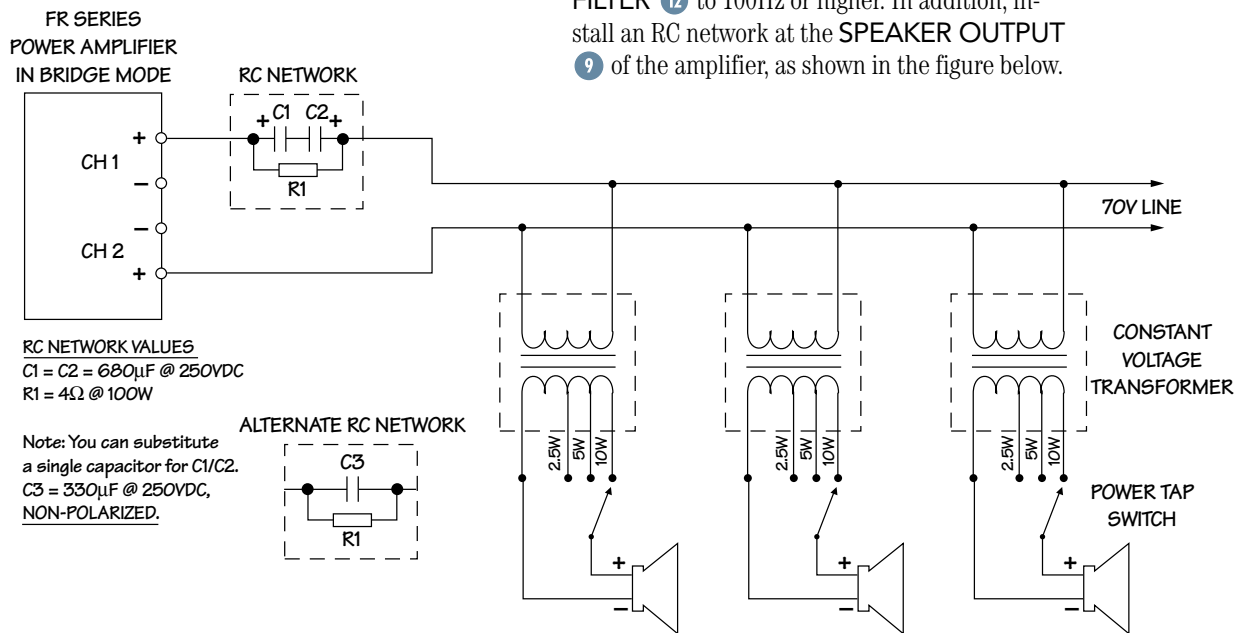

70V CONSTANT VOLTAGE DISTRIBUTION SYSTEM

APPENDIX A: Service Info

If you think your amplifier has a problem, please do everything you can to confirm it before calling for service, including reading through the following Troubleshooting section. Doing so might save you from the deprivation of your Mackie amplifier and the associated suffering.

Of all Mackie products returned for service (which is hardly any at all), roughly 50% are coded “CND” — Could Not Duplicate, which usually means the problem lay somewhere else in the system. These may sound obvious to you, but here are some things you can check:

TROUBLESHOOTING

No power!

- Our favorite question: Is it plugged in? Make sure the AC outlet is live (check with a tester or lamp).
- Our next favorite question: Is the POWER switch **7** on? If not, try turning it on.
- Is the green light next to the power switch illuminated? If not, make sure the AC outlet is live. If so, refer to “No Sound” below.
- The AC line fuse inside the cabinet is blown. *This is not a user-serviceable part.* Refer to “Repair” on the next page to find out how to proceed.

No sound!

- Are the GAIN **1** controls turned all the way down? Slowly turn them up and see if you hear anything.
- Is the signal source turned up? Make sure the signal level from the mixing console (or whatever device immediately precedes the amplifier) is high enough to produce sound in the amplifier. The SIG **3** LEDs should be blinking to indicate that signal is present.
- If the speakers are wired for BRIDGE mode, make sure the AMP MODE **15** switch is set to BRIDGE **18**.
- If the OUTPUT APPLICATION **19** switch is set to SUBWOOFER **21**, make sure the LOW CUT FILTER **12** frequency control is set to OFF or nearly OFF. If it is turned up above the subwoofer cutoff frequency, the output from the amplifier will be diminished.

- Is the SHORT **5** LED lit? Turn the POWER off, check the speaker connections and make sure that there are no strands of wire shorting across the speaker terminals.
- Is the HOT TEMP STATUS **6** LED lit? Make sure there is cool air available at the front of the amplifier. Make sure there is room at the sides of the amplifier for warm air to exit. Allow the amplifier to cool off.
- Are there fuses in the speaker or in-line fuses in the speaker wire? Check 'em to see if they're blown.
- Make sure the speakers are working properly.

One side is way louder than the other!

- Do the M•1400/M•1400i's meters **2** read the same on both sides? If not, your source signal may be delivering an out-of-balance stereo signal.
- Are both GAIN **1** knobs set to the same position?
- Are the speaker(s) impedances matched?
- Try swapping sides: Turn off the amp, swap the speaker cables at the amp, turn the amp back on. If the same side is still louder, the problem is with your speakers or speaker cabling. If the other side is louder now, the problem is with the mixer, the amp, or the line-level cabling.

The stereo music sounds kind of sideways, and the bass frequencies diminish when standing center, but get louder as you approach one side!

- Check the polarity of the speaker cable connections. You may have your positive and negative connections reversed at one end of one speaker cable.

As soon as the music gets loud, the amp shuts down!

- Check the M•1400/M•1400i's meters **2**. Be sure that OL is not lighting up frequently or continuously.
- Can the amp breathe? The M•1400/M•1400i amp draws its ventilation air in from the front and out through the side panels. It needs plenty of fresh air to stay cool. **Do not block the ventilation ports.**

- Is the **SHORT 5** LED lit? If so, you've got a dead short somewhere in your speaker setup, or the total impedance of the load is too low. Turn the amp off and rectify that right away.

Something's missing in the mid and high frequencies!

- If you're using horns with compression drivers, please read **CONSTANT DIRECTIVITY 13**.

It hurts when I touch my arm, or my leg, or even my head!

- You have a broken finger.

Bad sound!

- Is it loud and distorted? Turn down the signal coming from the mixer or signal source.
- Is the input connector plugged completely into the jack? Check the speaker connections and verify that all connections are tight and that there are no stray strands of wire shorting across the speaker terminals.
- If possible, listen to the signal source with headphones plugged into the console. If it sounds bad there, the problem's not in the amplifier.

Noise/Hum

- Check the signal cable between the mixer and the amplifier. Make sure all connections are good and sound.
- Make sure the signal cable is not routed near AC cables, power transformers, or other EMI-inducing device.
- Is there a light dimmer or other SCR-based device on the same AC circuit as the monitor? Use an AC line filter or plug the amplifier into a different AC circuit.
- If possible, listen to the signal source with headphones plugged into the console. If it sounds noisy there, the problem's not in the amplifier.

For additional up-to-date information please visit our website at www.mackie.com.

REPAIR

Service for the M•1400/M•1400i amplifiers purchased in the USA is available only from one of our authorized domestic service stations. It is also available at the factory, located in sunny Woodinville, Washington. (Service for Mackie amplifiers living outside the United States can be obtained through local dealers or distributors.) If your amplifier needs service, and it lives in the United States, follow these instructions:

1. Review the preceding troubleshooting suggestions. Please.
2. Call Tech Support at 1-800-258-6883, 8am to 5pm PST, to explain the problem and request an RA (Return Authorization) number. Have your amplifier's serial number ready. *You must have an RA number before you can obtain service at the factory or an authorized service center.*
3. Keep this owner's manual. We don't need it to repair the amplifier.
4. Pack the amplifier in its original package, including endcaps and box. This is *very important*. When you call for the RA number, please let Tech Support know if you need new packaging. *Mackie is not responsible for any damage that occurs due to non-factory packaging.*
5. Include a legible note stating your name, shipping address (no P.O. boxes), daytime phone number, RA number, and a detailed description of the problem, including how we can duplicate it.
6. Write the RA number in **BIG PRINT** on top of the box.
7. Ship the amplifier to us. We suggest insurance for all forms of cartage. Ship to this address:

Mackie Designs
SERVICE DEPARTMENT
16140 Wood-Red Rd. NE Ste. 5
Woodinville, WA 98072
8. We'll try to fix the amplifier within five business days. Ask Tech Support for current turn-around times when you call for your RA number. We normally send everything back prepaid using UPS ORANGE (three-day air). However, if you rush your amplifier to us by Next Day Air, we'll ship it back to you UPS RED (Next Day Air). This paragraph does not necessarily apply to non-warranty service.

APPENDIX B: Technical Info

SPECIFICATIONS



SPECIFICATIONS M•1400/M•1400i

Continuous Average Output Power, both channels driven:

250 watts per channel into 8 ohms from 20Hz to 20kHz, with no more than 0.012% THD

425 watts per channel into 4 ohms from 20Hz to 20kHz, with no more than 0.025% THD

630 watts per channel into 2 ohms from 20Hz to 20kHz, with no more than 0.050% THD

Bridged mono operation:

850 watts into 8 ohms from 20Hz to 20kHz, with no more than 0.025% THD

1260 watts into 4 ohms from 20Hz to 20kHz, with no more than 0.050% THD

Maximum Power at 1% THD:

300 watts per channel into 8 ohms

500 watts per channel into 4 ohms

700 watts per channel into 2 ohms

1000 watts into 8 ohms bridged

1400 watts into 4 ohms bridged

Note: Power ratings are specified at 120VAC (U.S. and Canada) and 240VAC (Export) line voltages.

The M•1400/M•1400i power amplifier draws large amounts of current from the AC line with continuous sine wave testing. Accurate measurement of power requires a steady and stable AC supply. This means the line impedance must be very low to insure that the peak AC line voltage does not sag to less than 97% of its value.

If driving highly reactive loads, we recommend that the limiter circuit be engaged.

Power Bandwidth:

20Hz to 70kHz (+0, -3 dB)

Frequency Response:

20Hz to 40kHz (+0, -1 dB)

10Hz to 70kHz (+0, -3 dB)

Distortion:

THD, SMPTE IMD, TIM < 0.025% @ 8Ω

< 0.050% @ 4Ω

< 0.150% @ 2Ω

Signal-to-Noise Ratio:

> 107 dB below rated power into 4 ohms

Channel Separation:

> 80 dB @ 1kHz

Damping Factor:

> 350 from 0 to 400Hz

Input Impedance:

20kΩ balanced bridging

Input Sensitivity:

1.23 volts (+4 dBu) for rated power into 4 ohms

Gain:

30.25 dB (32.5V/V)

Maximum Input Level:

9.75 volts (+22 dBu)

Rise Time:

< 4.4μs

Slew Rate:

Voltage Slew Rate > 50V/μs

> 100V/μs bridged

Current Slew Rate > 32A/μs at 2Ω

CMRR:

> 40 dB, 20Hz to 20kHz

Load Angle:

8(±jx) time independent at 8Ω

4(±jx) time dependent, T > 6 min. at 4Ω

2(1±jx) time dependent, T > 2 min. at 2Ω

Transient Recovery:

< 1μs for 20 dB overdrive @ 1kHz

High Frequency Overload and Latching:

No latch up at any frequency or level.

High Frequency Stability:

Unconditionally stable driving any reactive or capacitive load.

Turn On Delay:

3 seconds

Variable Low-Cut Filter:

10Hz (Off) to 170Hz, 2nd Order Bessel

Subwoofer Low-Pass Filter:

Switched: 63Hz/125Hz, 3rd Order Bessel

Constant Directivity High Frequency Boost:

2kHz to 6kHz (+3 dB points)

6 dB/octave high-frequency shelving filter, (shelving occurs at approximately 30kHz)

Limiter Section:

Complementary Positive and Negative Peak Detecting

Indicators:

- 6 meter LEDs per channel
 - SIG (Signal Present), -20, -9, -6, -3, OL (Overload)
- CH 1 & 2
 - PROTECT LEDs
 - SHORT LEDs
- TEMP STATUS
 - COLD/HOT LEDs

Power Consumption:

- 65 watts at idle
- 900 watts with musical program fully loaded
(2 ohms per side, or 4 ohms bridged)
- 550 watts with musical program fully loaded
(4 ohms per side, or 8 ohms bridged)
- 850 watts at full power into 8 ohms
(continuous sine wave)
- 1500 watts at full power into 4 ohms
(continuous sine wave)
- 2500 watts at full power into 2 ohms
(continuous sine wave)

AC Line Power:

U.S./Canada	120VAC, 60Hz
Europe	240VAC, 50Hz
Japan	100VAC, 50/60Hz
Korea	220VAC, 60Hz

AC Drop-out Voltage:

At approximately 50% of rated line voltage

Physical:

Height	3.5 inches (89mm)
Width	19.0 inches (483mm)
Depth	15.25 inches (387mm)
Overall Depth	16.25 inches (413mm)
Weight	36 pounds (16.3kg)

Since we are always striving to make our stuff better at Mackie Designs by incorporating new and improved materials, components, and manufacturing methods, we reserve the right to change these specifications at any time without notice.

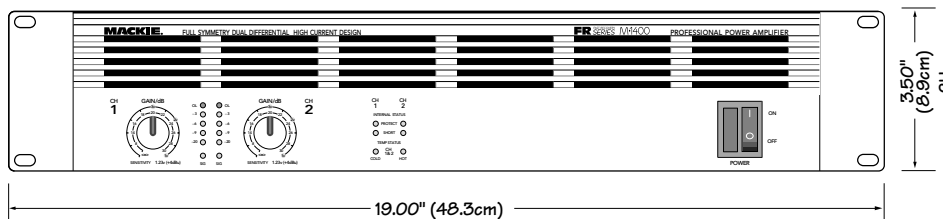
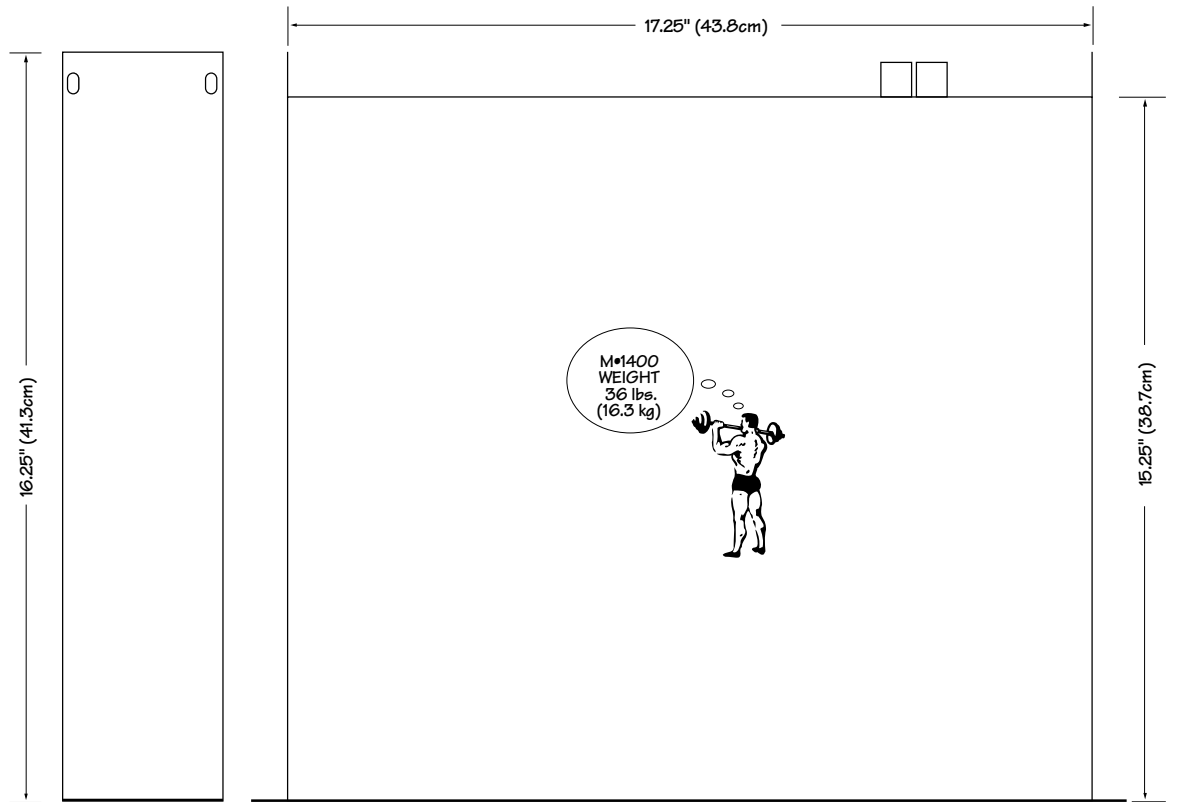

BLOCK DIAGRAM M•1400/ M•1400i

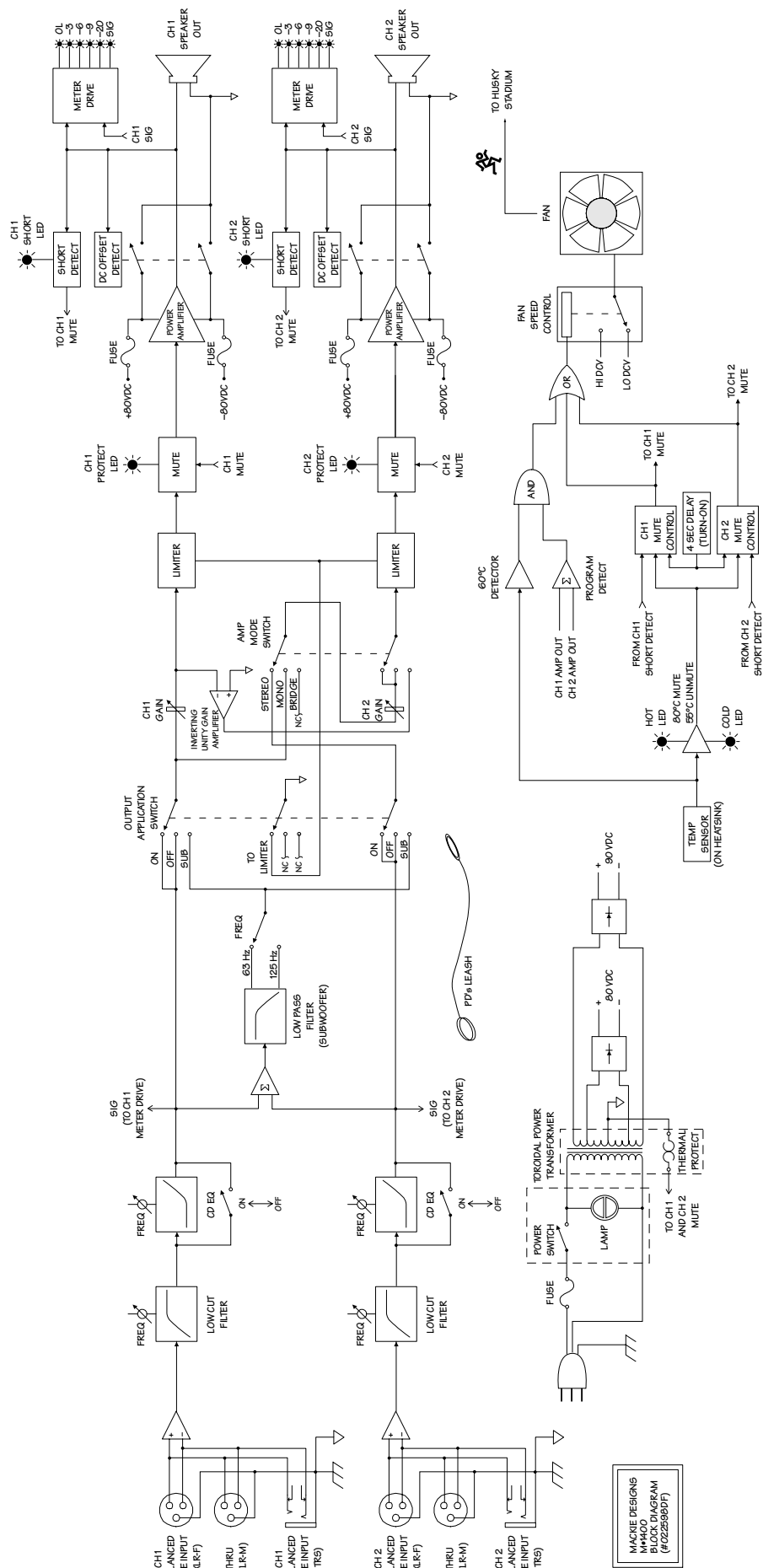

COLOPHON

Manual written by Jeff Gilbert and Dave Franzwa, with tidbits borrowed from almost everywhere, including huge chunks of technically baffling text contributed by Rick Chinn. Manual then defaced with proofreading pens in the hands of Mackie's legendary Tech Support staff (Paul Larson), New Products Engineering staff (Cal Perkins and Cameron Jones), and our incomparable Art Department (Sara Delahan). Back cover collage composed by Jayme Delma.

Manual composed with No. 4 blue sidewalk chalk on the banks of beautiful Sammamish Slough by Mackie's notorious Technical Writing staff, then converted to this amazing piece of work using a 13-story 1000 gigawhat Macintosh, powered by its own dedicated AC supply with extensive voltage regulation and noise filtering to insure pure, undistorted text. Please, feel free to let us know if you find an error or stumble over a confusing paragraph. Thank you for reading the entire manual (we know you have, or you wouldn't be here).

Mackie, The Running Man, and FR Series are either trademarks or registered trademarks of Mackie Designs Inc.

Speakon is a registered trademark of Neutrik.

All other brand names mentioned are registered trademarks or trademarks of their respective holders, and are hereby acknowledged.

©2001 Mackie Designs Inc.
All Rights Reserved.

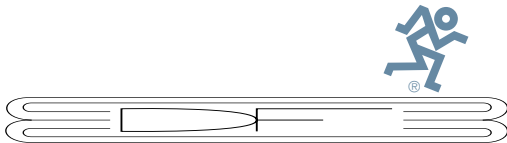



*Some of the
people at our
factory who helped
design, build, sell,
and support your
product.*

MACKIE®

Mackie Designs Inc.

16220 Wood-Red Rd. NE • Woodinville, WA 98072 • USA
US & Canada: 800/898-3211

Europe, Asia, Central & South America: 425/487-4333

Middle East & Africa: 31-20-654-4000

Fax: 425/487-4337 • www.mackie.com

E-mail: sales@mackie.com