

## Dual Enhancement Mode MOSFET (N-and P-Channel)

### Features

- N-Channel  
30V/5A,  $R_{DS(ON)}=35m\Omega(\text{typ.}) @ V_{GS}=10V$   
 $R_{DS(ON)}=60m\Omega(\text{typ.}) @ V_{GS}=4.5V$
- P-Channel  
-30V/-3.5A,  $R_{DS(ON)}=85m\Omega(\text{typ.}) @ V_{GS}=-10V$   
 $R_{DS(ON)}=135m\Omega(\text{typ.}) @ V_{GS}=-4.5V$
- Super High Dense Cell Design for Extremely Low  $R_{DS(ON)}$
- Reliable and Rugged
- SO-8 Package

### Applications

- Power Management in Notebook Computer , Portable Equipment and Battery Powered Systems.

### Pin Description

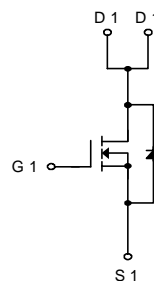
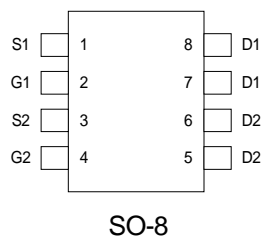

N-Channel MOSFET

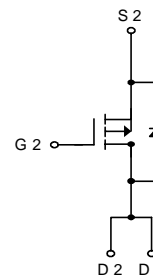

P-Channel MOSFET

### Ordering and Marking Information

<p>APM4532 <span style="border: 1px solid black; padding: 2px;">□□-□□</span></p> <div style="margin-left: 20px;"> <p>└─── Handling Code</p> <p>└─── Temp. Range</p> <p>└─── Package Code</p> </div>	<p>Package Code K : SO-8</p> <p>Operation Junction Temp. Range C : -55 to 150°C</p> <p>Handling Code TR : Tape &amp; Reel</p>
<p>APM4532 K : <span style="border: 1px solid black; padding: 2px; display: inline-block; text-align: center;">APM4532 XXXXX</span></p>	<p>XXXXX - Date Code</p>

ANPEC reserves the right to make changes to improve reliability or manufacturability without notice, and advise customers to obtain the latest version of relevant information to verify before placing orders.

**Absolute Maximum Ratings** ( $T_A = 25^\circ\text{C}$  unless otherwise noted)

Symbol	Parameter	N-Channel	P-Channel	Unit	
$V_{DSS}$	Drain-Source Voltage	30	-30	V	
$V_{GSS}$	Gate-Source Voltage	$\pm 25$	$\pm 25$		
$I_D^*$	Maximum Drain Current – Continuous	5	-3.5	A	
$I_{DM}$	Maximum Drain Current – Pulsed	20	-20		
$P_D$	Maximum Power Dissipation	$T_A=25^\circ\text{C}$	2	2	W
		$T_A=100^\circ\text{C}$	0.8	0.8	
$T_J$	Maximum Junction Temperature	150		$^\circ\text{C}$	
$T_{STG}$	Storage Temperature Range	-55 to 150		$^\circ\text{C}$	
$R_{\theta JA}$	Thermal Resistance – Junction to Ambient	62.5		$^\circ\text{C}/\text{W}$	

\* Surface Mounted on FR4 Board,  $t \leq 10$  sec.

**Electrical Characteristics** ( $T_A = 25^\circ\text{C}$  unless otherwise noted)

Symbol	Parameter	Test Condition	APM4532			Unit	
			Min.	Typ.	Max.		
<b>Static</b>							
$BV_{DSS}$	Drain-Source Breakdown Voltage	$V_{GS}=0V, I_{DS}=250\mu\text{A}$	N-Ch	30			V
			P-Ch	-30			
$I_{DSS}$	Zero Gate Voltage Drain Current	$V_{DS}=24V, V_{GS}=0V$	N-Ch			1	$\mu\text{A}$
		$V_{DS}=-24V, V_{GS}=0V$	P-Ch			-1	
$V_{GS(th)}$	Gate Threshold Voltage	$V_{DS}=V_{GS}, I_{DS}=250\mu\text{A}$	N-Ch	1	1.5	2	V
		$V_{DS}=V_{GS}, I_{DS}=-250\mu\text{A}$	P-Ch	-1	-1.5	-2	
$I_{GSS}$	Gate Leakage Current	$V_{GS}=\pm 25V, V_{DS}=0V$	N-Ch			$\pm 100$	nA
			P-Ch			$\pm 100$	
$R_{DS(ON)}^a$	Drain-Source On-state Resistance	$V_{GS}=10V, I_{DS}=5A$	N-Ch		35	45	m $\Omega$
		$V_{GS}=4.5V, I_{DS}=4A$			60	70	
		$V_{GS}=-10V, I_{DS}=-3.5A$	P-Ch		85	95	
		$V_{GS}=-4.5V, I_{DS}=-2.5A$			135	150	
$V_{SD}^a$	Diode Forward Voltage	$I_{SD}=1.7A, V_{GS}=0V$	N-Ch		0.7	1.3	V
		$I_{SD}=-1.7A, V_{GS}=0V$	P-Ch		-0.7	-1.3	

**Notes**

<sup>a</sup> : Pulse test ; pulse width  $\leq 300\mu\text{s}$ , duty cycle  $\leq 2\%$

Electrical Characteristics (Cont.) ( $T_A = 25^\circ\text{C}$  unless otherwise noted)

Symbol	Parameter	Test Condition	APM4532			Unit
			Min.	Typ.	Max.	
<b>Dynamic<sup>a</sup></b>						
Q <sub>g</sub>	Total Gate Charge	N-Channel V <sub>DS</sub> =10V , I <sub>DS</sub> = 5A	N-Ch	7	15	nC
			P-Ch	8	15	
Q <sub>gs</sub>	Gate-Source Charge	V <sub>GS</sub> =4.5V P-Channel	N-Ch	4.7		
			P-Ch	2		
Q <sub>gd</sub>	Gate-Drain Charge	V <sub>DS</sub> =-10V , I <sub>DS</sub> =-3.5A V <sub>GS</sub> =-4.5V	N-Ch	1.1		
			P-Ch	1		
t <sub>d(ON)</sub>	Turn-on Delay Time	N-Channel V <sub>DD</sub> =10V , I <sub>DS</sub> =1A , V <sub>GEN</sub> =4.5V , R <sub>G</sub> =10Ω	N-Ch	10	15	ns
T <sub>r</sub>	Turn-on Rise Time		P-Ch	8	15	
t <sub>d(OFF)</sub>	Turn-off Delay Time	P-Channel V <sub>DD</sub> =-10V , I <sub>DS</sub> =-1A , V <sub>GEN</sub> =-4.5V , R <sub>G</sub> =10Ω	N-Ch	8	20	
			P-Ch	7	20	
T <sub>f</sub>	Turn-off Fall Time		N-Ch	20	28	
			P-Ch	15	28	
C <sub>iss</sub>	Input Capacitance	V <sub>GS</sub> =0V	N-Ch	5	15	
			P-Ch	7	18	
C <sub>oss</sub>	Output Capacitance	V <sub>DS</sub> =15V Frequency=1.0MHz	N-Ch	376		pF
			P-Ch	495		
C <sub>rss</sub>	Reverse Transfer Capacitance		N-Ch	115		
			P-Ch	130		
			N-Ch	58		
			P-Ch	60		

Notes

<sup>a</sup> : Guaranteed by design, not subject to production testing

# Typical Characteristics

N-Channel

Output Characteristics

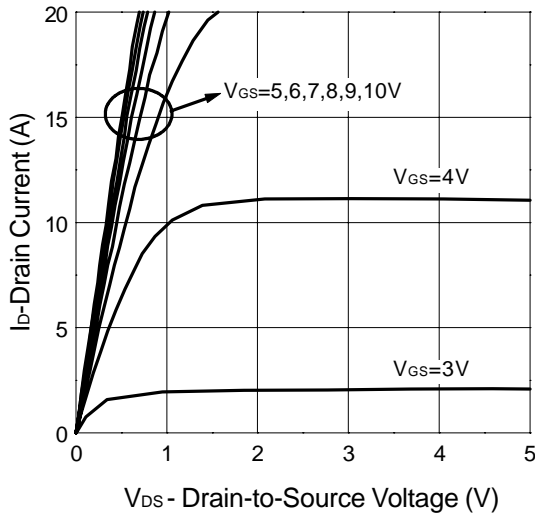

Transfer Characteristics

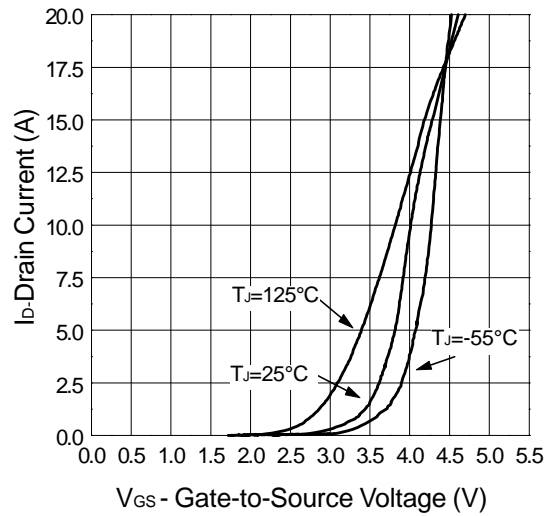

Threshold Voltage vs. Junction Temperature

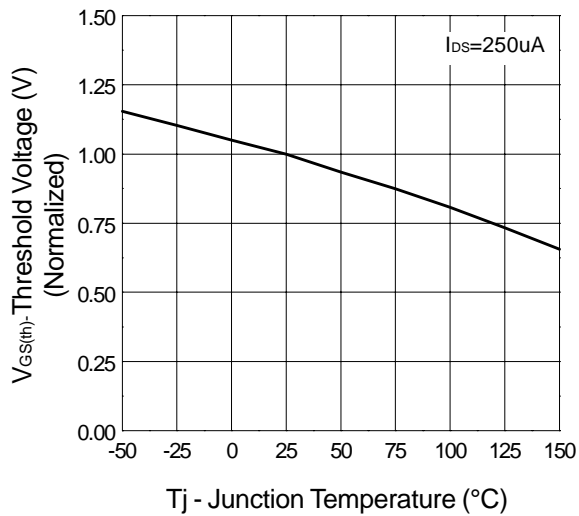

On-Resistance vs. Drain Current

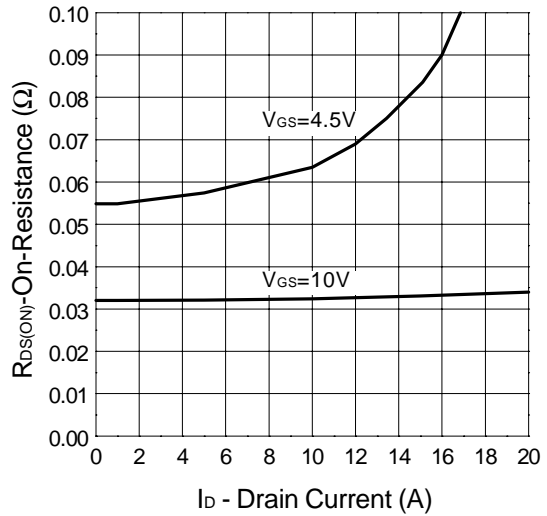

## Typical Characteristics (Cont.)

N-Channel

On-Resistance vs. Gate-to-Source Voltage

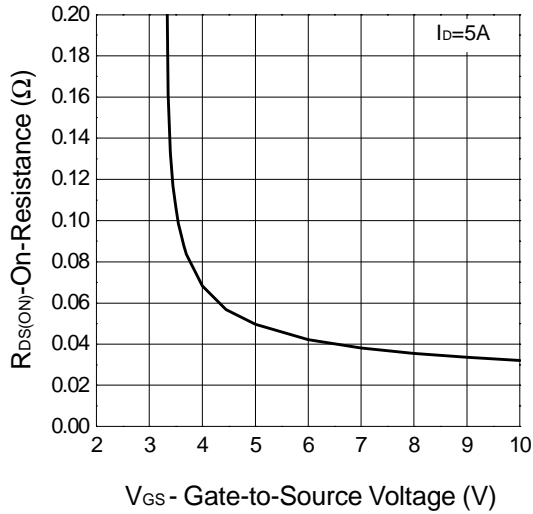

On-Resistance vs. Junction Temperature

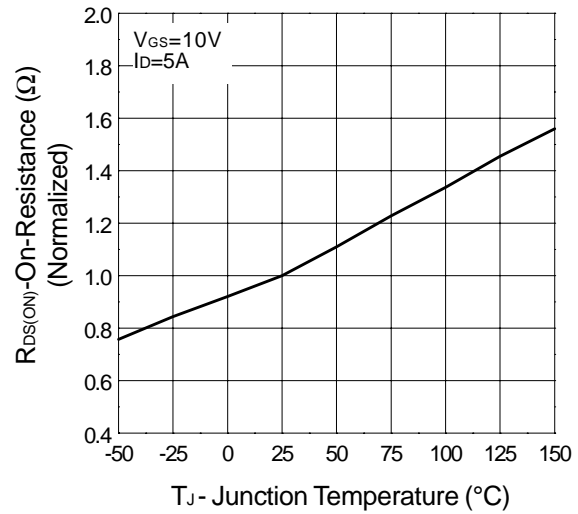

Gate Charge

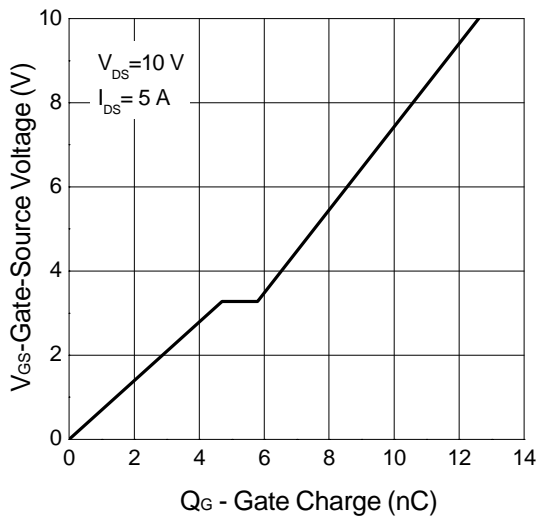

Capacitance

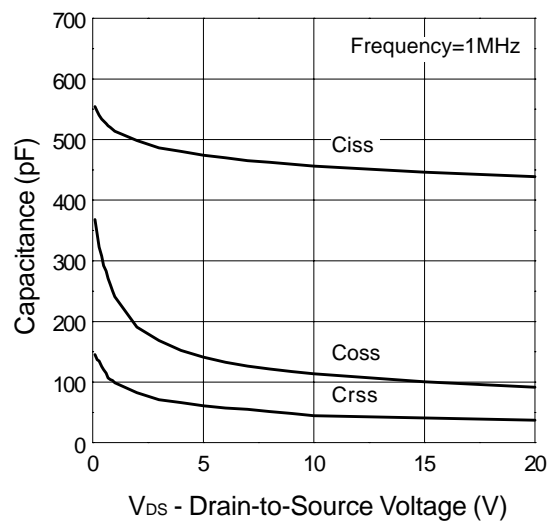

# Typical Characteristics (Cont.)

N-Channel

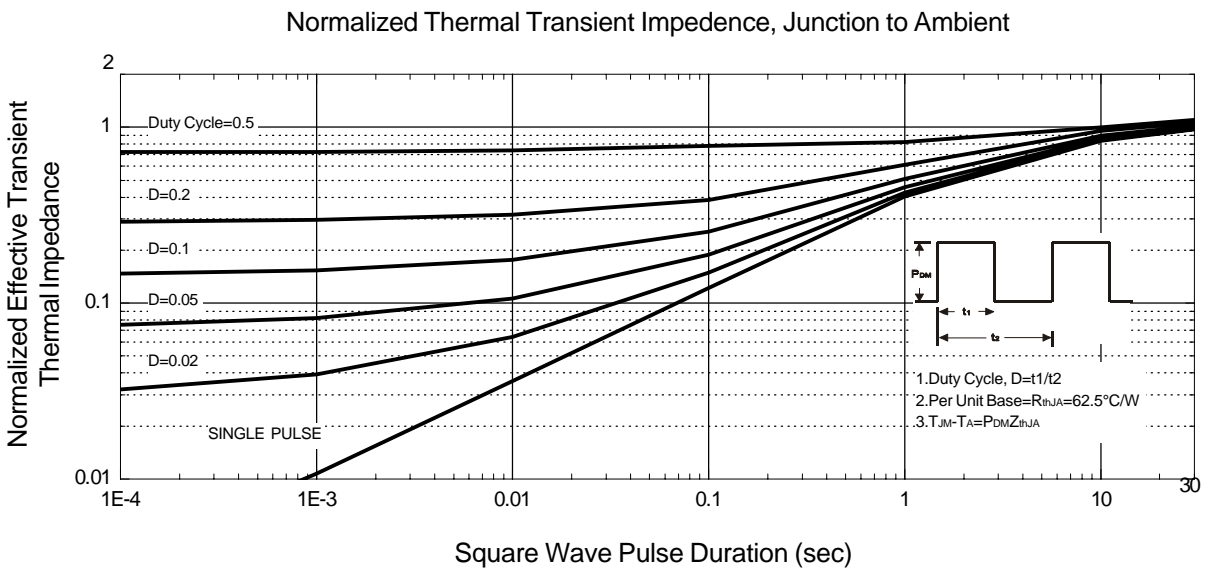
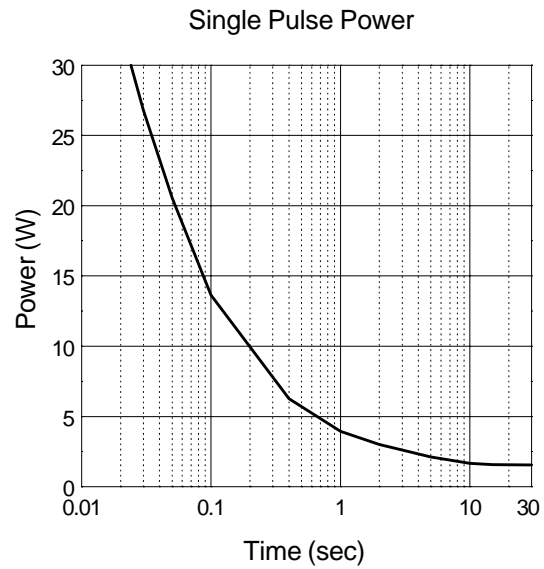
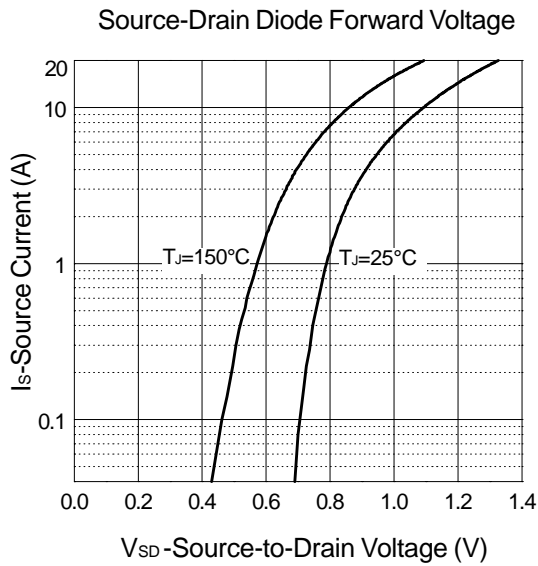

# Typical Characteristics

P-Channel

Output Characteristics

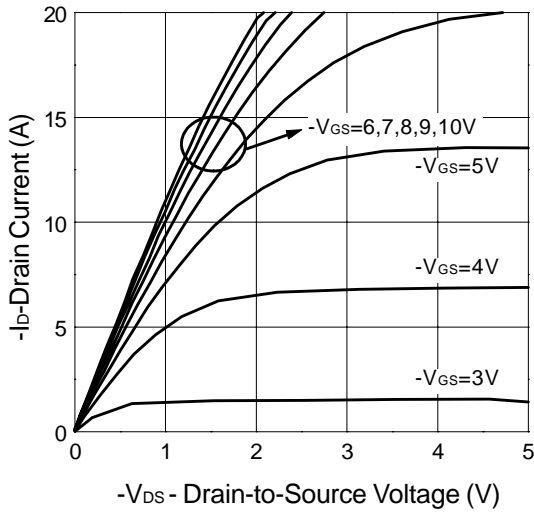

Transfer Characteristics

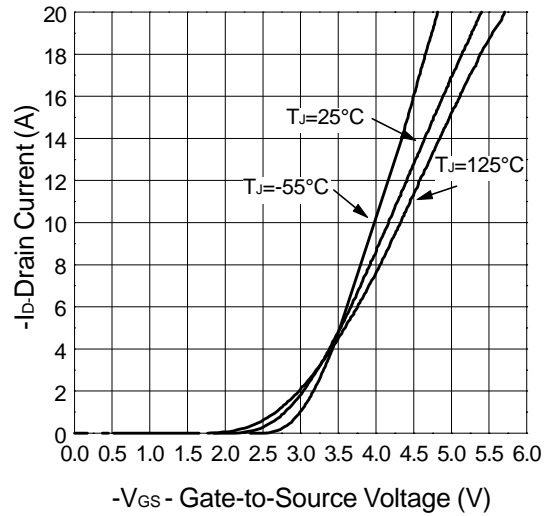

Threshold Voltage vs. Junction Temperature

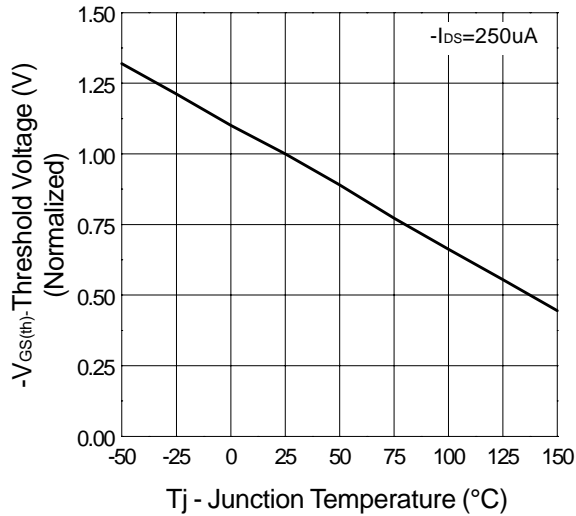

On-Resistance vs. Drain Current

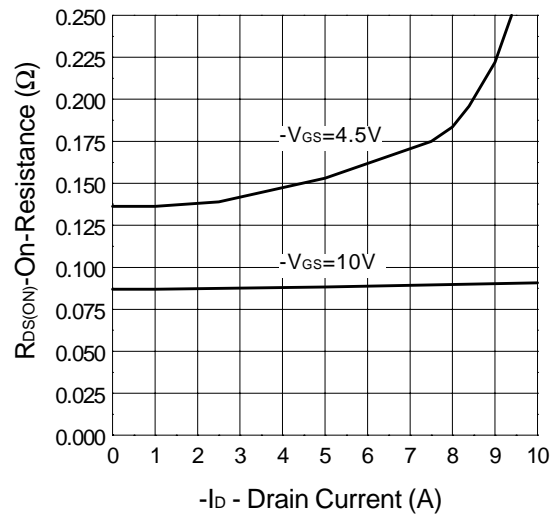

## Typical Characteristics (Cont.)

P-Channel

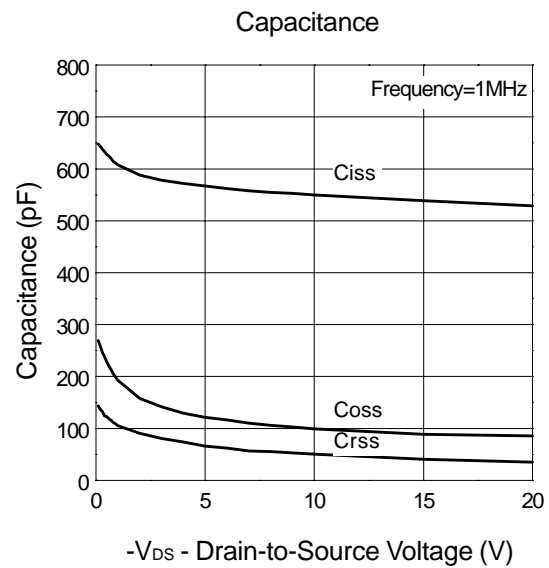
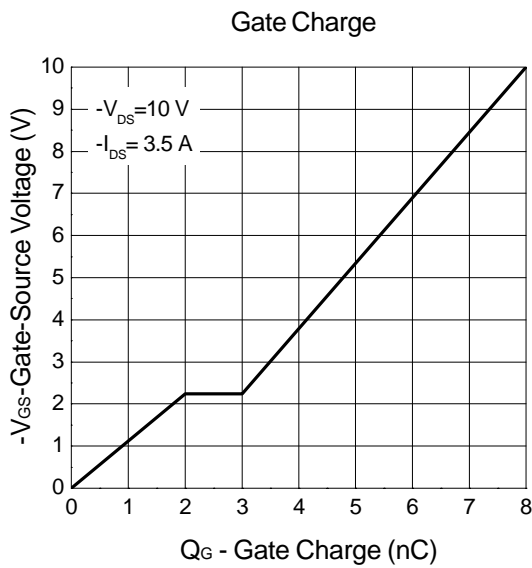
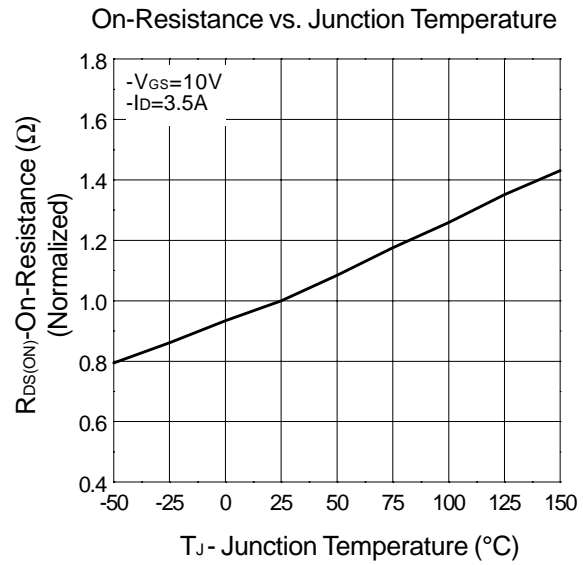
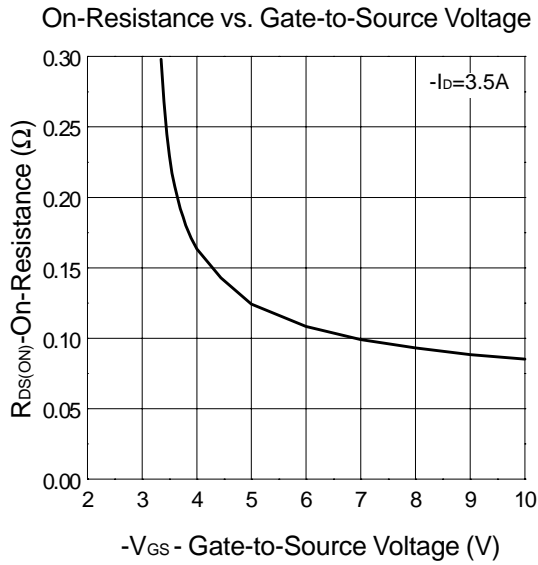

# Typical Characteristics (Cont.)

P-Channel

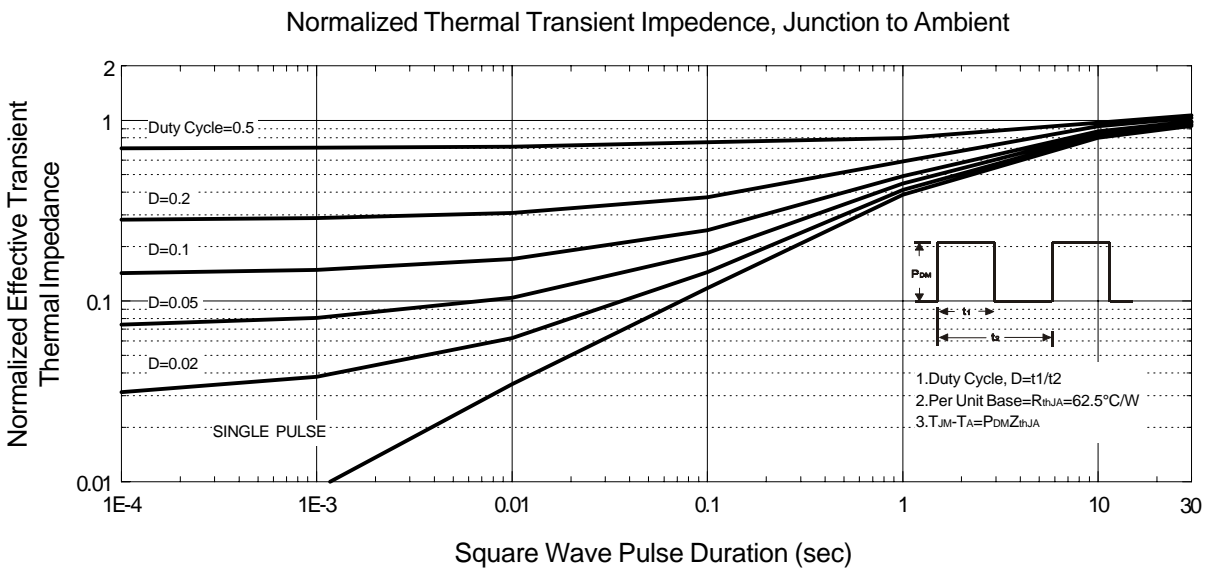
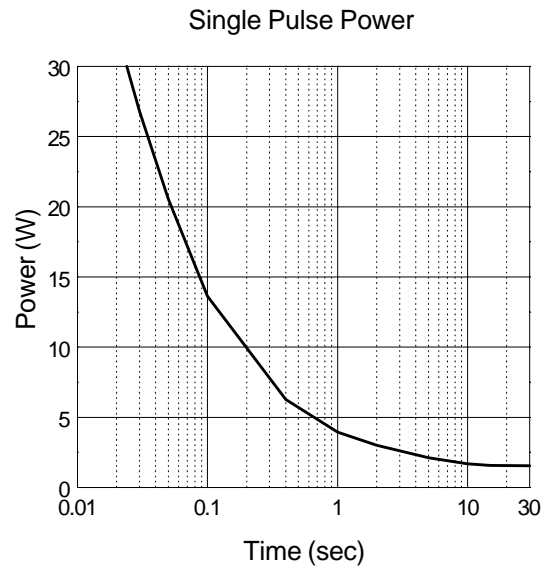
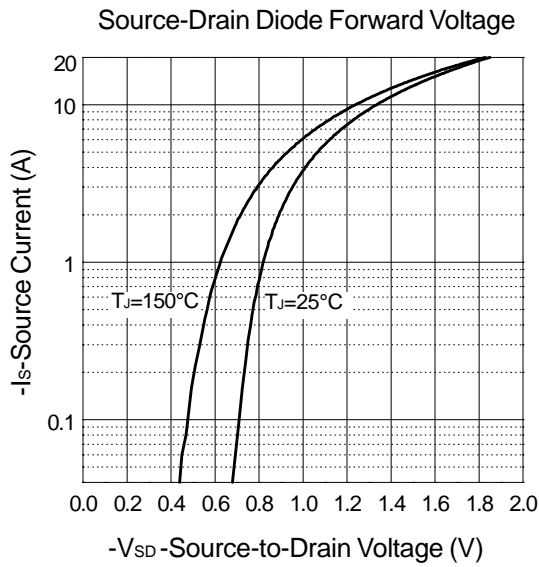

## Packaging Information

SOP-8 pin ( Reference JEDEC Registration MS-012)

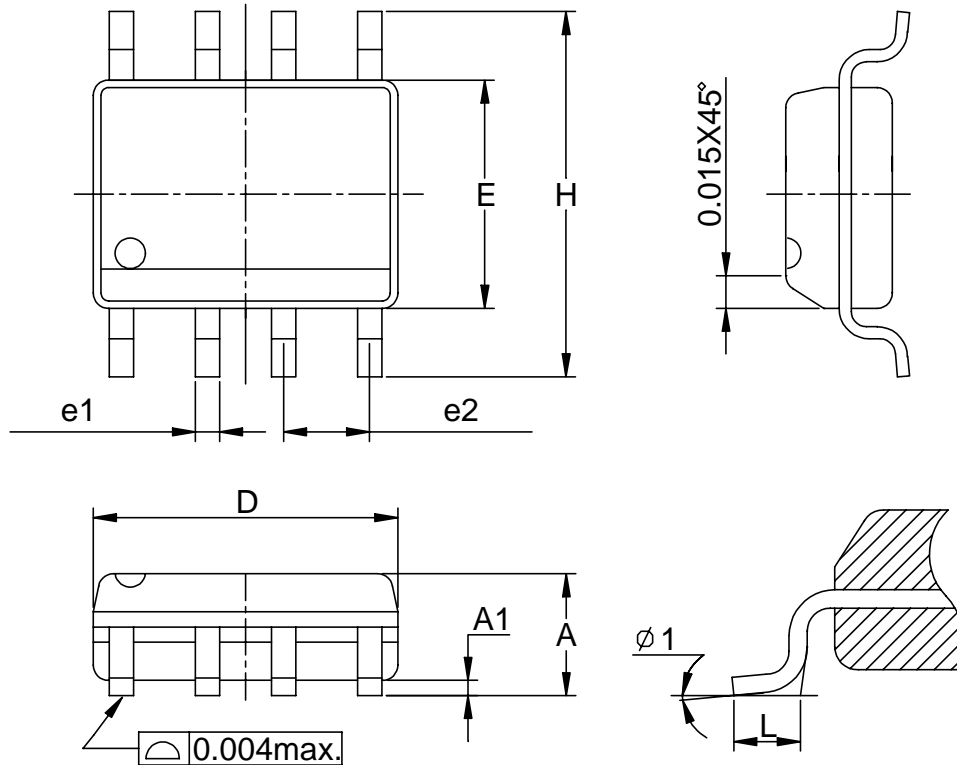

Dim	Millimeters		Inches	
	Min.	Max.	Min.	Max.
A	1.35	1.75	0.053	0.069
A1	0.10	0.25	0.004	0.010
D	4.80	5.00	0.189	0.197
E	3.80	4.00	0.150	0.157
H	5.80	6.20	0.228	0.244
L	0.40	1.27	0.016	0.050
e1	0.33	0.51	0.013	0.020
e2	1.27BSC		0.50BSC	
φ 1	8°		8°	

## Physical Specifications

Terminal Material	Solder-Plated Copper (Solder Material : 90/10 or 63/37 SnPb)
Lead Solderability	Meets EIA Specification RSI86-91, ANSI/J-STD-002 Category 3.

## Reflow Condition (IR/Convection or VPR Reflow)

Reference JEDEC Standard J-STD-020A APRIL 1999

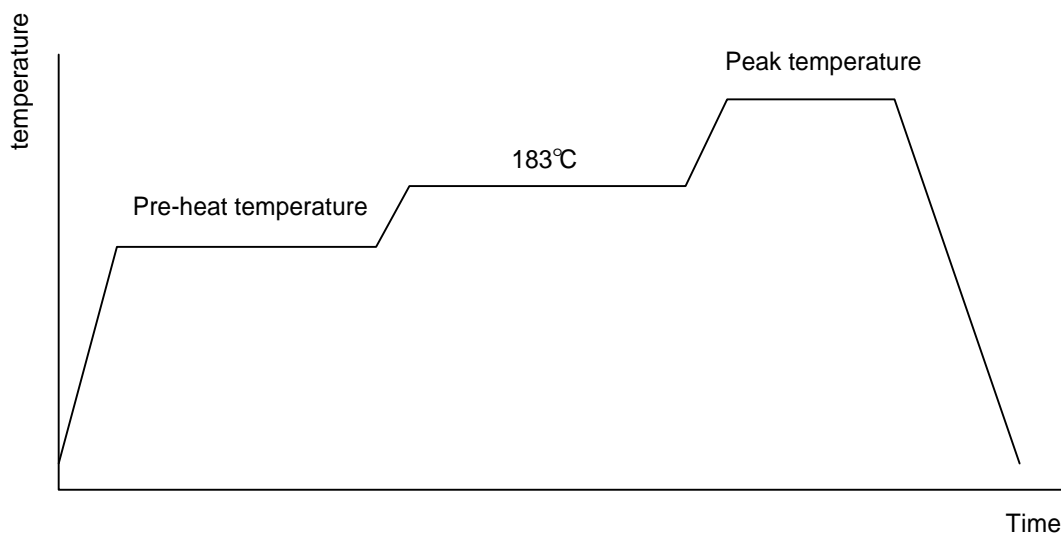

## Classification Reflow Profiles

	Convection or IR/ Convection	VPR
Average ramp-up rate(183°C to Peak)	3°C/second max.	10 °C /second max.
Preheat temperature 125 ± 25°C)	120 seconds max	
Temperature maintained above 183°C	60 – 150 seconds	
Time within 5°C of actual peak temperature	10 –20 seconds	60 seconds
Peak temperature range	220 +5/-0°C or 235 +5/-0°C	215-219°C or 235 +5/-0°C
Ramp-down rate	6 °C /second max.	10 °C /second max.
Time 25°C to peak temperature	6 minutes max.	

## Package Reflow Conditions

pkg. thickness ≥ 2.5mm and all bgas	pkg. thickness < 2.5mm and pkg. volume ≥ 350 mm <sup>3</sup>	pkg. thickness < 2.5mm and pkg. volume < 350mm <sup>3</sup>
Convection 220 +5/-0 °C		Convection 235 +5/-0 °C
VPR 215-219 °C		VPR 235 +5/-0 °C
IR/Convection 220 +5/-0 °C		IR/Convection 235 +5/-0 °C

## Reliability test program

Test item	Method	Description
SOLDERABILITY	MIL-STD-883D-2003	245°C, 5 SEC
HOLT	MIL-STD 883D-1005.7	1000 Hrs Bias @ 125°C
PCT	JESD-22-B, A102	168 Hrs, 100% RH, 121°C
TST	MIL-STD 883D-1011.9	-65°C ~ 150°C, 200 Cycles

## Carrier Tape & Reel Dimensions

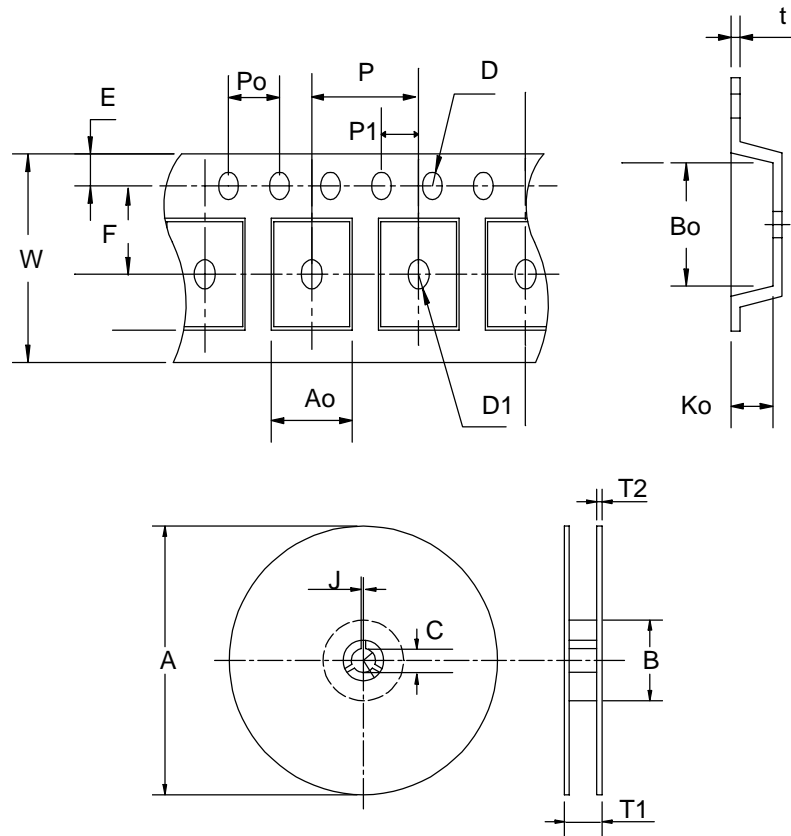

Application	A	B	C	J	T1	T2	W	P	E
SOP- 8	330 ± 1	62 +1.5	12.75+ 0.15	2 ± 0.5	12.4 ± 0.2	2 ± 0.2	12 ± 0.3	8 ± 0.1	1.75 ± 0.1
	F	D	D1	Po	P1	Ao	Bo	Ko	t
	5.5 ± 1	1.55 + 0.1	1.55 + 0.25	4.0 ± 0.1	2.0 ± 0.1	6.4 ± 0.1	5.2 ± 0.1	2.1 ± 0.1	0.3 ± 0.013

## Cover Tape Dimensions

Application	Carrier Width	Cover Tape Width	Devices Per Reel
SOP- 8	12	9.3	2500

## Customer Service

### **Anpec Electronics Corp.**

#### Head Office :

5F, No. 2 Li-Hsin Road, SBIP,

Hsin-Chu, Taiwan, R.O.C.

Tel : 886-3-5642000

Fax : 886-3-5642050

#### Taipei Branch :

7F, No. 137, Lane 235, Pac Chiao Rd.,

Hsin Tien City, Taipei Hsien, Taiwan, R. O. C.

Tel : 886-2-89191368

Fax : 886-2-89191369

This datasheet has been downloaded from:

[www.DatasheetCatalog.com](http://www.DatasheetCatalog.com)

Datasheets for electronic components.